

Acme®

MANA PROFILE

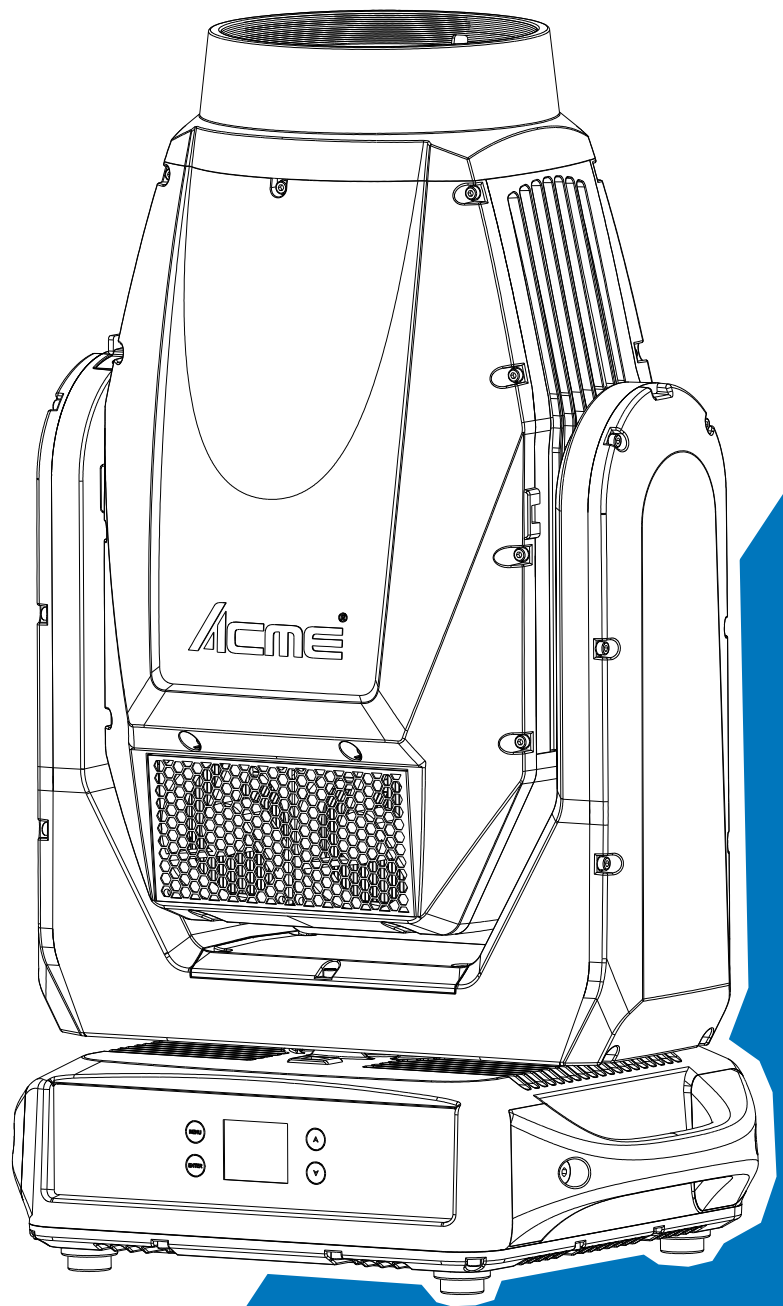

User Manual

Please read the instruction carefully before use

CONTENTS

01/ Safety Information.....	2
02/ Technical Specifications	6
03/ Overview.....	8
04/ Connecting Power and Data	9
4.1 Connecting Power.....	9
4.2 Connecting Data.....	10
05/ Fixture Installation.....	11
06/ Effect Wheels.....	13
07/ Operation	14
7.1 Control Menu.....	14
7.2 Updating Software	29
7.3 Home Position Adjustment	31
08/ Configuring the Device for DMX Control.....	39
8.1 Address Setting.....	39
8.2 DMX Protocol.....	40
09/ Error Information	45
10/ Troubleshooting	55
11/ Fixture Cleaning.....	56
12/ Approvals and Certifications	57

01/ Safety Information



Please read the instruction carefully which includes important information about the installation, usage and maintenance.

WARNING

Please keep this User Guide for future consultation. If you sell the unit to another user, be sure that they also receive this instruction manual.

Important:

Damages caused by the disregard of this user manual are not subject to warranty. The dealer will not accept liability for any resulting defects or problems.

- Unpack and check carefully to ensure that there is no transportation damage before using the unit.
- This product is suitable for wet locations. Do not immerse in water.
- DO install and operate by qualified operator.
- DO NOT allow children to operate the fixture.
- Use safety chain (made of steel, min. diameter 4.0mm) when fixing the unit. Handle the unit by carrying its base instead of head only.
- The unit must be installed in a location with adequate ventilation, at least 50cm from adjacent surfaces.
- Be sure that no ventilation slots is blocked, otherwise the unit will be overheated.
- Before operation, ensure that you are connecting this product to the proper voltage in accordance with the specifications in this manual or on the product's specification label.
- It's important to ground the yellow/green conductor to earth in order to avoid electric shock.
- Minimum ambient temperature TA: 0°C. Maximum ambient temperature TA: 40°C. Do not operate this product at a lower or higher temperature.
- DO NOT connect the device to any dimmer pack.
- Keep flammable materials away from the fixture while operating to avoid fire hazard.
- Make sure the power cord is not crimped or damaged; replace it immediately if damaged.
- Unit's surface temperature may reach up to 75°C. DO NOT touch the housing bare-handed during its operation.
- Avoid any flammable liquids, water or metal from entering the unit. Once it happens, cut

off the mains power immediately.

- DO NOT operate in a dirty or dusty environment. DO clean the fixture regularly.
- DO NOT touch any wire during operation as there might be a hazard of electric shock.
- Avoid entanglement of the power cord with other wires.
- The minimum distance to objects/surface must be more than 5 meters.
- In the event of serious operating problem, stop using the unit immediately.
- Never turn on and off the unit time after time.
- The housing, the lenses, or the ultraviolet filter must be replaced if they are visibly damaged.
- DO NOT open the housing as there are no user serviceable parts inside.
- DO NOT attempt to operate this unit if it becomes damaged. DO NOT attempt any repairs yourself. Repairs carried out by unskilled people can lead to damage or malfunction. Please contact the nearest authorized technical assistance center if needed.
- Disconnect this product from its power source before servicing.
- DO use the original packaging if the device is to be transported.
- Avoid direct eye exposure to the light source while the product is on.
- DO NOT operate this product if you see damage on the housing, shields, or cables. Have the damaged parts replaced by an authorized technician at once.

01/ Consignes de sécurité



Veillez lire attentivement les instructions qui contiennent des informations importantes sur l'installation, l'utilisation et l'entretien.

ATTENTION

Veillez conserver ce guide de l'utilisateur pour une consultation future. Si vous vendez l'appareil à un autre utilisateur, assurez-vous qu'il reçoive également ce manuel d'instructions.

Important:

Les dommages causés par le non-respect de ce manuel d'utilisation ne sont pas couverts par la garantie. Le revendeur n'acceptera aucune responsabilité pour les défauts ou problèmes qui en résultent.

- Déballez et vérifiez soigneusement qu'il n'y a pas de dommages dus au transport avant d'utiliser l'appareil.
- Ce produit convient aux endroits humides. Ne pas immerger dans l'eau.
- L'installation et la mise en fonctionnement doit être effectué par un opérateur qualifié.
- NE PAS permettre aux enfants d'utiliser l'appareil.
- Utilisez une chaîne de sécurité lors de la fixation de l'unité. Manipulez l'appareil en portant sa base au lieu de la tête uniquement.
- L'unité doit être installée dans un endroit avec une ventilation adéquate, à au moins 50cm des surfaces adjacentes.
- Assurez-vous qu'aucune fente d'aération du luminaire n'est obstruée, sinon il risque de surchauffer.
- Avant toute utilisation, assurez-vous que vous connectez ce luminaire à la tension appropriée conformément aux spécifications que vous trouverez dans ce manuel ou sur l'étiquette des spécifications collée sur la base du luminaire.
- Il est important de relier le file jaune/vert à la terre afin d'éviter tout choc électrique.
- Température ambiante minimale TA: 0°C. Température ambiante maximale TA: 40°C. N'utilisez pas ce luminaire à des températures inférieures ou supérieures.
- NE PAS connecter le luminaire à un pack de gradateurs.
- Gardez les matériaux inflammables à l'écart du luminaire pendant le fonctionnement pour éviter tout risque d'incendie.

- Assurez-vous que le cordon d'alimentation n'est pas pincé ou endommagé; remplacez-le immédiatement s'il est endommagé.
- La température de surface de l'unité peut atteindre 75°C. NE PAS toucher les capots à mains nues pendant son fonctionnement.
- Évitez que des liquides inflammables, de l'eau ou du métal ne pénètrent dans l'appareil. Si cela se produit, coupez immédiatement l'alimentation secteur.
- NE PAS utiliser le luminaire dans un environnement sale ou poussiéreux. Cette appareil doit être nettoyer régulièrement.
- NE touchez AUCUN file pendant le fonctionnement car il pourrait y avoir un risque de choc électrique.
- Évitez l'enchevêtrement du cordon d'alimentation avec d'autres fils.
- La distance minimale de projection sur des objets ou sur des surfaces doit être supérieure à 5 mètres.
- En cas de problème de fonctionnement grave, arrêtez immédiatement d'utiliser l'appareil.
- N'allumez et n'éteignez jamais ce luminaire à maintes reprises.
- Le boîtier, les lentilles ou le filtre ultraviolet doivent être remplacés s'ils sont visiblement endommagés.
- NE PAS ouvrir le boîtier car il ne contient aucune pièce réparable par l'utilisateur.
- NE PAS mettre ce luminaire en fonctionnement s'il est endommagé. N'effectuez pas de réparations vous-même. Les réparations ne doivent être effectuées par des personnes non qualifiées, cela peut entraîner des dommages ou des dysfonctionnements. Veuillez contacter le centre d'assistance technique agréé le plus proche si nécessaire.
- Débranchez ce produit du secteur avant de procéder à l'entretien.
- Utiliser l'emballage d'origine si l'appareil doit être transporté.
- Évitez une exposition directe des yeux à la source lumineuse lorsque le produit est allumé.
- N'utilisez PAS ce produit si vous constatez des dommages sur le boîtier, les blindages ou les câbles. Faites remplacer immédiatement les pièces endommagées par un technicien agréé.

02/ Technical Specifications

AC Power	100-240V~ 50/60Hz	
Max. Power Consumption	910W	
Light Source	SCL600CF-80-R72	
Color Temperature	7000K	
Zoom Range	3.5°-45°	
Color Wheel	5 colors + CRI + CTB + open	
Gobo Wheels	Static Gobo Wheel	9 gobos + open
	Rotating Gobo Wheel	8 replaceable gobos + open
Movement	Pan	540°
	Tilt	260°
	16 bit movement resolution	
	Automatic pan/tilt repositioning	
	Mechanical pan/tilt lock for safe transportation and maintenance	
Control and Programming	DMX Channels	40/31/31/22
	Protocols	DMX512
		RDM
		Art-Net
		sACN
Firmware Update	via DMX or USB memory device	
Construction	Display	LCD display
	DMX and RDM Data In/Out	5-pin IP XLR (optional with 3-pin IP XLR)
		RJ45 Connectors
	Power In/Out	Waterproof Power Connector in/out
Protection Rating	IP66	
Dynamic Effects	High CRI Mode: Ra≥90	
	0-100% continuous dimming and strobe effects	
	Choice of four dimming curves	
	CMY color mixing	
	Variable color temperature control	

	Animation wheel: continuous rotation with variable speed and direction	
	Iris: Variable 0-100%	
	Prisms: two indexing/rotating prisms (4-facet circular prism and 4-facet linear prism)	
	Frost: soft frost effect and heavy frost effect	
	Motorized zoom	
	Motorized focus	
	Framing: rotatable framing module, +/-60°, 4 x individually controllable full framing blades with variable angle and position	
Included Items	Power Cable with Neutrik true1 power connector	
	Two omega brackets with 1/4-turn fasteners	
	User Manual (this document)	
Dimensions	379.5x284x657.8mm	14.9"x11.2"x25.9"
Weight	32.5 kg	71.7 lbs

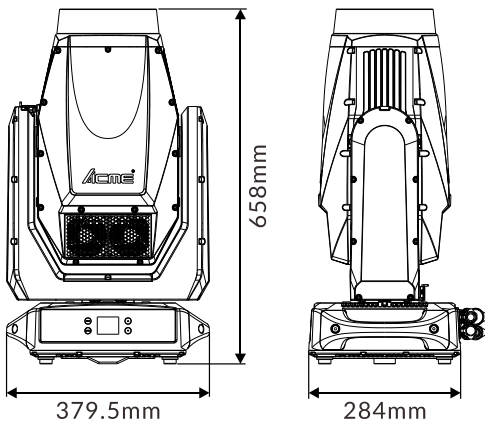

Photometric Diagram:

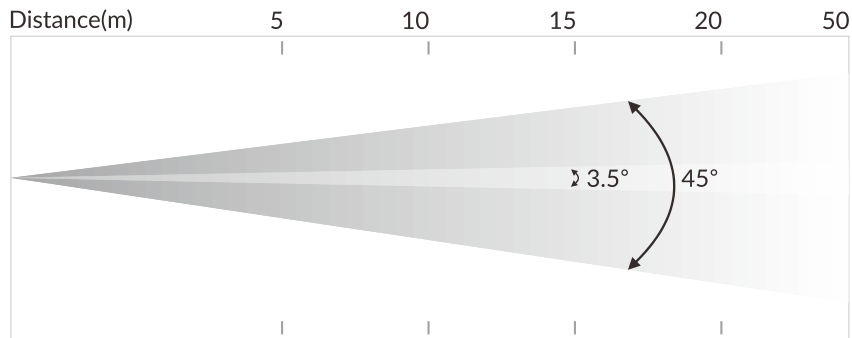

3.5° Lux	130,000	30,200	13,955	7,850	1,256
Diameter(m)	0.3	0.7	0.9	1.2	3.1
45° Lux	2,750	804	370	208	34
Diameter(m)	3.9	7.9	11.8	15.8	39.4

03/ Overview

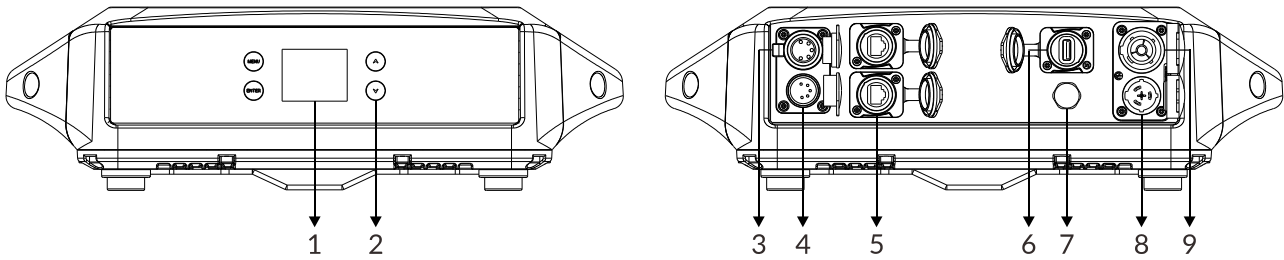

1. Display	To show the various menus and the selected function	
2. Buttons	MENU	To enter into move backward or leave the menu
	▲ UP	To go backward to move up in the menu
	▼ DOWN	To go forward to move down in the menu
	ENTER	To perform the desired functions
3. DMX OUT	For DMX512 link, use 5-pin XLR cable to link the next units to output DMX signal (optional with 3-pin IP XLR)	
4. DMX IN	For DMX512 link, use 5-pin XLR cable to link the unit and DMX controller to input DMX signal (optional with 3-pin IP XLR)	
5. ETHERNET	Transfers fixture's information to a main controller	
6. FIRMWARE UPGRADE	Used to upgrade fixture's firmware	
7. RELEASE VALVE		
8. POWER IN	To connect to supply power	
9. POWER OUT	To connect to the next fixture	

04/ Connecting Power and Data

4.1 Connecting Power

To apply power, first check that the head pan and tilt locks are released.

This fixture can operate on any 100-240V~ 50/60Hz AC mains power supply.

The maximum power consumption is 910W.

The fixture must be grounded/earthed and able to be isolated from AC power. The AC power supply must incorporate a fuse or circuit breaker for fault protection.

Wiring and connection work must be carried out by a qualified electrician.

The power cable color coding is given in the figure below:

Wire	Color (US)	Wire	Color (EU)	Symbol	Conductor
	black		brown	L	live
	white		blue	N	neutral
	green		yellow/green	\perp or \oplus	ground (earth)

Power cord set that should be used: Listed SJOW flexible cord with rating: 300V, 105°C, VW-1, 16AWG x 3C, molded with 5-15P attachment plug and terminated with cord connector model RCAC3F-X-000-01 with rating 250V, 16A by Neutrik Technology(Ningbo) Co.,Ltd. The power cord shall be at least 914mm (It is to be measured from the face of attachment plug to the face of connector).

CAUTION!

DO NOT CONNECT THE FIXTURE TO AN ELECTRICAL DIMMER SYSTEM AS DOING SO MAY CAUSE DAMAGE.

4.2 Connecting Data

The fixture is equipped with 5-pin (or 3-pin) XLR sockets for DMX input and output. Use a high-quality DMX cable designed for RS-485 and 5-pin (or 3-pin) XLR-plugs and connectors in order to connect the controller with the fixture or one fixture with another. For outdoor installations, use only IP-rated XLR connectors suitable for outdoor use.

Building a serial DMX chain:

Connect the DMX data output from the controller to the fixture's data input socket. Connect the DMX output of the first fixture in the DMX chain with the DMX input of the next fixture. Always connect one output with the input of the next fixture until all fixtures are connected. Up to 32 fixtures can be connected to the same DMX link. Terminate the DMX out cable of the last fixture in the data link with a 120 ohm DMX terminator.

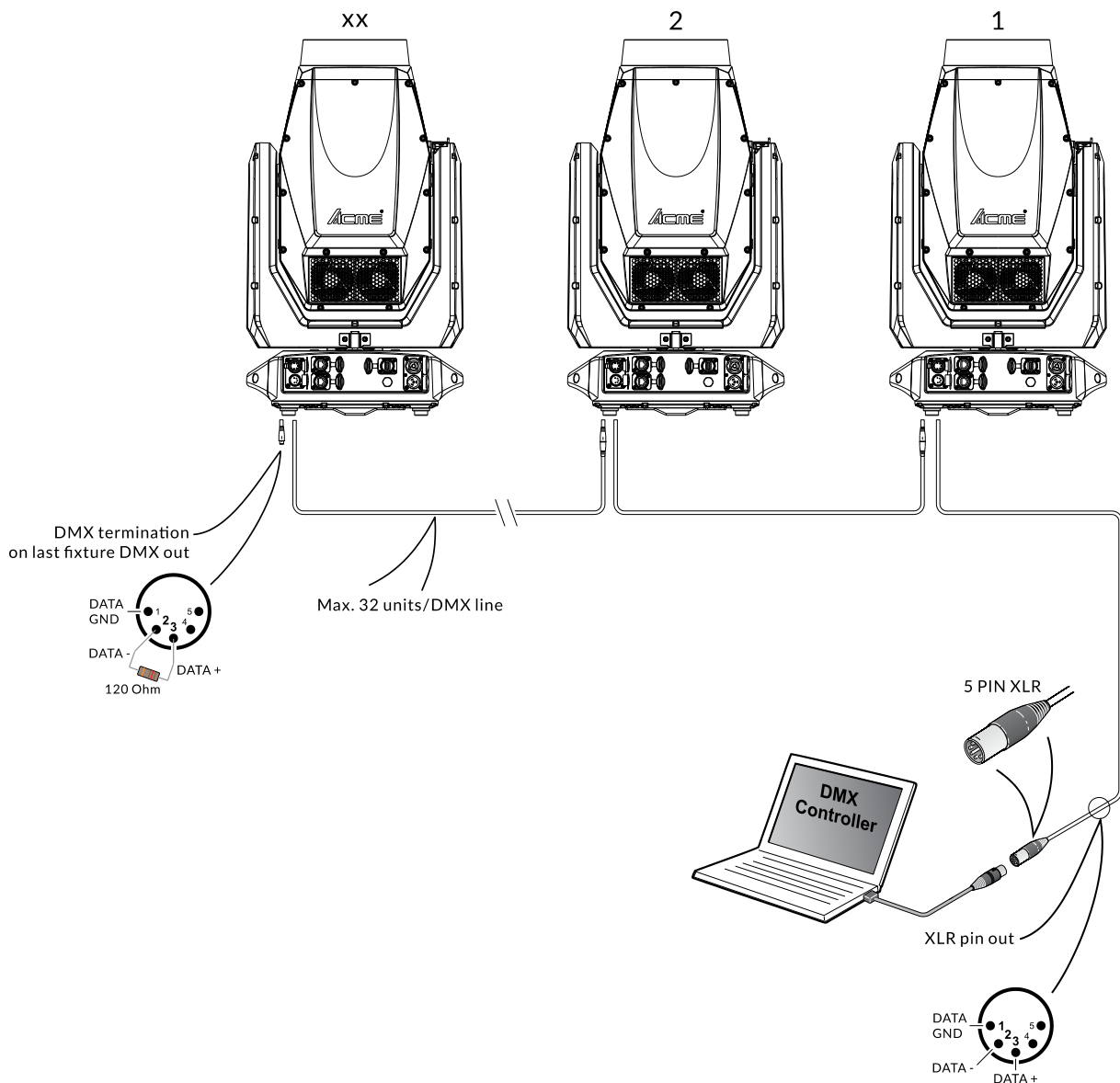

05/ Fixture Installation

The fixture is IP66-rated and designed for both indoor and outdoor events. This means that it is protected from:

- ▶ Dust, to the degree that dust cannot enter the device in sufficient quantities as to interfere with its operation.
- ▶ Water jets from any direction.

DO install and operate by qualified operator. Fixture(s) should be installed in areas outside walking paths, seating areas, or away from areas where unauthorized personnel might reach the fixture by hand. NEVER stand directly below the fixture(s) when rigging, removing or servicing.

Always ensure that the unit is firmly fixed to avoid vibration and slipping off during operation. Ensure that the trussing or area of installation must be able to hold 10 times the weight without any deformation. Always attach a safety cable (made of steel, min. diameter 4.0mm) that can hold at least 12 times the weight of the fixture whenever installing this fixture in a suspended environment to ensure that the fixture will not fall if the clamp fails.

This fixture is fully operational in three different mounting positions: hanging upside-down, mounted sideways on trussing, or standing on the floor. Always use and install a safety cable as a safety measure to prevent accidental damage and/or injury in the event the clamp fails. This fixture is suitable for theaters, studios, and similar locations.

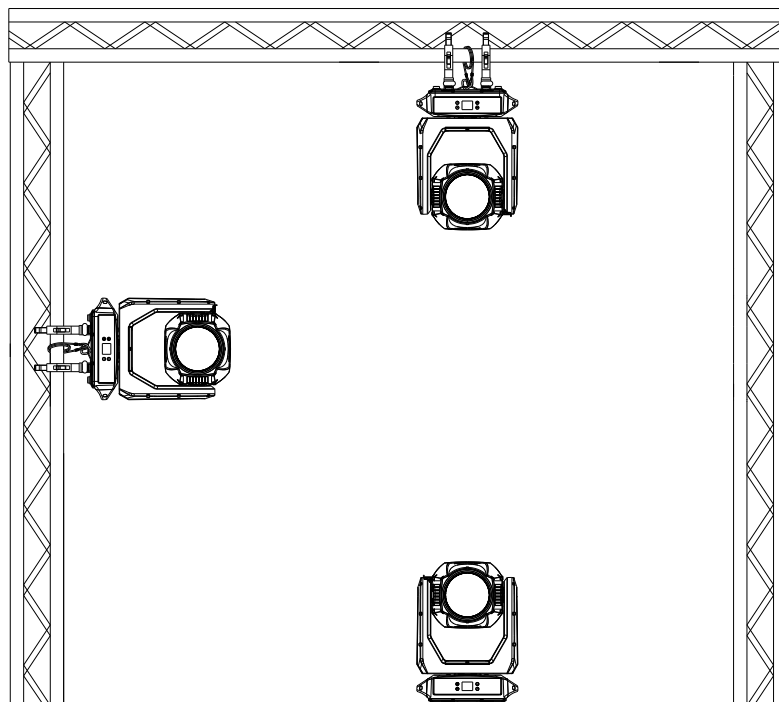

Steps for installing omega brackets:

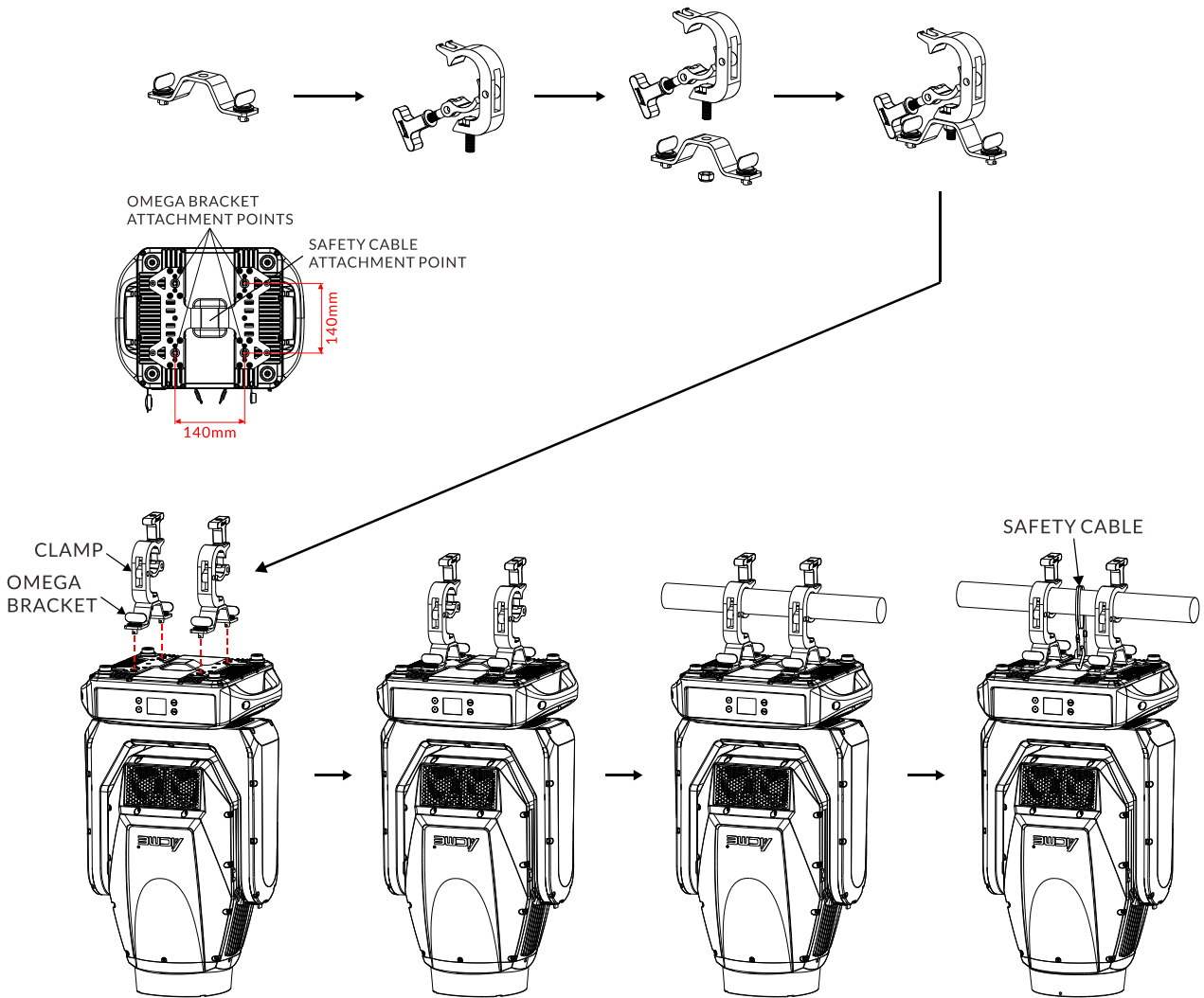

06/ Effect Wheels

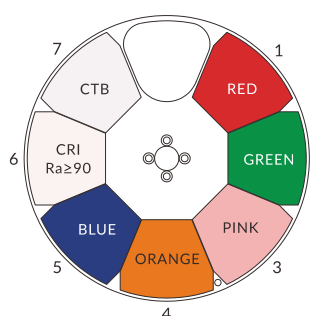

Color Wheel

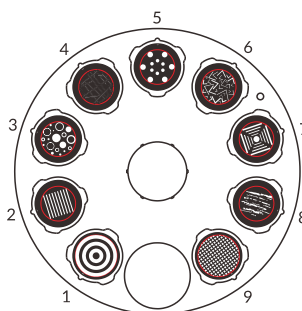

Static Gobo Wheel

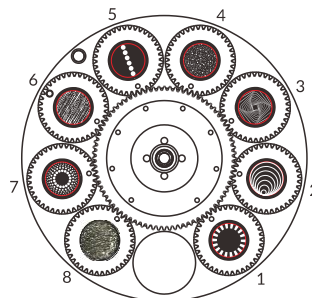

Rotating Gobo Wheel

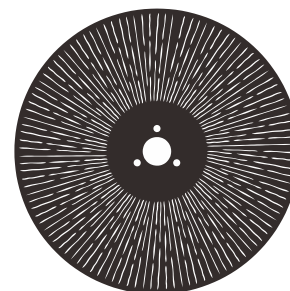

Animation Wheel
3011001514

DANGER!

Replace the gobos with the device switched off only.
Unplug from mains before replacing the gobos!

Static Gobo Wheel		
Slot	Name	Part Number
Open	Empty	/
1	Target	3011001510
2	Bars	3011001513
3	Mixed Beams	3011001547
4	Cross Stripes	3011001506
5	Concentric Dots	3011001507
6	Multiple Angles	3011001508
7	Square Tunnel	3011001509
8	Clouds	3011001511
9	Grid	3011001512

Rotating Gobo Wheel		
Slot	Name	Part Number
Open	Empty	/
1	Broken Circle	3011001500
2	Eccentric Circles	3011001501
3	Dream Tunnel	3011001502
4	Tiny Bubbles	3011001503
5	Dots Line	3011001504
6	Linear Breakup	3011001505
7	Scattered Dots	3011001546
8	Diamond Glass	3015001230

Size of Static Gobos			
Slot	Gobo Diameter	Image Area Diameter	Glass Thickness
1~9	24mm+0/-0.2mm	18mm	1.1mm
Size of Rotating Gobos			
Slot	Gobo Diameter	Image Area Diameter	Glass Thickness
1~7	20mm+0/-0.2mm	17mm	1.1mm
8	20mm+0/-0.2mm	/	2.5mm

7.1 Control Menu

- ▶ To access the control menus, press the [MENU] button.
- ▶ Navigate the menu structure, using the [ENTER], [▲ UP] and [▼ DOWN] buttons.
- ▶ To select a menu option or to confirm a selection, press the [ENTER] button.
- ▶ To return to a higher level in the menu structure without making a change, press the [MENU] button, or wait 30 seconds.

The screen will be automatically locked if there is no operation for a long time, and can be unlocked by long-pressing the [MENU] button.

The main functions are shown below:

MAIN MENU	SUBMENU	CHOICES/VALUES	
DMX Settings	DMX Address	1-473 (40 CH)	(Default=1)
		1-482 (31 CH)	
		1-482 (31 CH)	
		1-491 (22 CH)	
	DMX Channel Mode	(40) Framing	
		(31) F-Wash	
		(31) Spot	
		(22) Wash	
	No DMX Status	Blackout	
		Hold	
		Manual	
	View DMX Value		
	Connect Option	Auto	
		DMX	
		Art-Net	
		sACN	
	Network	IP Address	Default 1:002.xxx.xxx.xxx
			Default 2:010.xxx.xxx.xxx
		Manual: xxx.xxx.xxx.xxx	
	Sub-Net Mask	xxx.xxx.xxx.xxx	
Art-Net Settings	Net	0-127	(Default=0)
	Sub-Net	0-15	(Default=0)
	Universe	0-15	(Default=0)

MAIN MENU	SUBMENU	CHOICES/VALUES		
	sACN Settings	Universe	1-32000	(Default=1)
		Priority	0-200	(Default=100)
	Network to DMX	No		
		Yes		
Fixture Settings	Pan Invert	No		
		Yes		
	Tilt Invert	No		
		Yes		
	P/T Feedback	No		
		Yes		
	Dimmer Speed	Fast		
		Smooth		
	Dimmer Curve	Linear		
		Square Law		
		Inv SQ Law		
		S Curve		
	Cooling Mode	Standard		
		Quiet		
	Led Refresh Rate	900Hz		
		1000Hz		
		1100Hz		
		1200Hz		
		1300Hz		
		1400Hz		
		1500Hz		
		2500Hz		
		4000Hz		
		5000Hz		
		6000Hz		
		10KHz		
		15KHz		
		20KHz		
25KHz				
Blade Mode	Mode 1			
	Mode 2			
Gobo Short Cut	Enable			
	Disable			

MAIN MENU	SUBMENU	CHOICES/VALUES	
	Color Short Cut	Enable	
		Disable	
Display Settings	Display Invert	No	
		Yes	
	Backlight Intensity	1-10	(Default=10)
	Temperature Unit	°C	
		°F	
	Language	English	
Chinese			
Fixture Test	Auto Test	Single	
		Cycle	
	Manual Test	Clear	No/Yes
		Pan	0-255
		Tilt	0-255
		Cyan	0-255
		Magenta	0-255
		Yellow	0-255
		CTO	0-255
		Color	0-255
		Gobo 1	0-255
		R-Gobo 1	0-255
		Gobo 2	0-255
		Animation	0-255
		Iris	0-255
		Prism 1	0-255
		R-Prism 1	0-255
		Prism 2	0-255
		R-Prism 2	0-255
		CRI	0-255
		Frost 1	0-255
		Frost 2	0-255
		Zoom	0-255
		Focus	0-255
		Strobe	0-255
		Dimmer	0-255
		Blade	0-255
		Blade DW 1	0-255
Blade DW 2	0-255		

MAIN MENU	SUBMENU	CHOICES/VALUES		
		Blade UP 1	0-255	
		Blade UP 2	0-255	
		Blade LF 1	0-255	
		Blade LF 2	0-255	
		Blade RG 1	0-255	
		Blade RG 2	0-255	
Fixture Information	Fixture Use Hour			
	LED Use Hour	Total LED Hour		
		LED On Hour		
		LED Hours Reset	Password=050	
	Temperature		Current	Max
		LED's		
	Humidity		Current	Max
		Base		
	Fan State	B_FAN 1-2		
		A_FAN 1		
		H_FAN 1-10		
	Firmware Version			
	RDM UID			
Error Logs	Fixture Errors			
	Reset Error Log	No		
		Yes	Password=050	
Reset Function	Pan/Tilt Reset	No		
		Yes		
	Effect Reset	No		
		Yes		
	All Reset	No		
		Yes		
Special Function	USB Upgrade	No		
		Yes		
	Send Upgrade	No		
		Yes		
	Firmware Restore	No		
		Yes		
	Factory Settings	No		
		Yes		

DMX Settings

Enter the control menu and select **DMX Settings**, press ENTER. Use the UP/DOWN button to select **DMX Address**, **DMX Channel Mode**, **No DMX Status**, **View DMX Value**, **Connect Option**, **Network**, **Art-Net Settings**, **sACN Settings** or **Network to DMX**.

DMX Address

Select **DMX Address**, press ENTER.

Use UP/DOWN button to select an address, confirm your selection with ENTER.

CHANNEL MODE	DMX ADDRESS
(40) Framing	1-473
(31) F-Wash	1-482
(31) Spot	1-482
(22) Wash	1-491

To exit the menu, press MENU, or wait 30 seconds.

DMX Channel Mode

Select **DMX Channel Mode**, press ENTER.

Use UP/DOWN button to select between **(40) Framing**, **(31) F-Wash**, **(31) Spot** and **(22) Wash**, confirm your selection with ENTER.

To exit the menu, press MENU, or wait 30 seconds.

No DMX Status

Select **No DMX Status**, press ENTER.

Use UP/DOWN button to select one of the following status:

Blackout (Fixture blacks out if DMX signal stops)

Hold (The device continues to operate in the current mode with the last active DMX values until the signal returns)

Manual (The device accepts the DMX value stored in the 'Manual Test' menu)

Confirm your selection with ENTER.

To exit the menu, press MENU, or wait 30 seconds.

View DMX Value

Select **View DMX Value**, press ENTER.

Use UP/DOWN button to select the desired DMX channel, for which the value is to be displayed.

To exit the menu, press MENU, or wait 30 seconds.

Connect Option

Select **Connect Option**, press ENTER.

Use UP/DOWN button to select **Auto**, **DMX**, **Art-Net** or **sACN**, confirm your selection with ENTER.

To exit the menu, press MENU, or wait 30 seconds.

Network

Select **Network**, press ENTER.

Use UP/DOWN button to select **IP Address** or **Subnet Mask**, confirm your selection with ENTER.

To exit the menu, press MENU, or wait 30 seconds.

Art-Net Settings

Select **Art-Net Settings**, press ENTER.

Use UP/DOWN button to select **Net**, **Sub-Net** or **Universe**, confirm your selection with ENTER.

To exit the menu, press MENU, or wait 30 seconds.

sACN Settings

Select **sACN Settings**, press ENTER.

Use UP/DOWN button to select **Universe** or **Priority**, confirm your selection with ENTER.

To exit the menu, press MENU, or wait 30 seconds.

Network to DMX

Select **Network to DMX**, press ENTER.

Use UP/DOWN button to select **No** or **Yes**, confirm your selection with ENTER.

To exit the menu, press MENU, or wait 30 seconds.

Fixture Settings

Enter the control menu and select **Fixture Settings**, press ENTER. Use the UP/DOWN button to select **Pan Invert**, **Tilt Invert**, **P/T Feedback**, **Dimmer Speed**, **Dimmer Curve**, **Cooling Mode**, **Led Refresh Rate**, **Blade Mode**, **Gobo Short Cut** or **Color Short Cut**.

Pan Invert

Select **Pan Invert**, press ENTER.

Use UP/DOWN button to select **No** (pan invert deactivated) or **Yes** (pan invert activated), confirm your selection with ENTER.

To exit the menu, press MENU, or wait 30 seconds.

Tilt Invert

Select **Tilt Invert**, press ENTER.

Use UP/DOWN button to select **No** (tilt invert deactivated) or **Yes** (tilt invert activated), confirm your selection with ENTER.

To exit the menu, press MENU, or wait 30 seconds.

P/T Feedback

Select **P/T Feedback**, press ENTER.

Use UP/DOWN button to select **No** (pan/tilt feedback deactivated) or **Yes** (pan/tilt feedback activated), confirm your selection with ENTER.

To exit the menu, press MENU, or wait 30 seconds.

Dimmer Speed

Select **Dimmer Speed**, press ENTER.

Use UP/DOWN button to select **Fast** or **Smooth**, confirm your selection with ENTER.

To exit the menu, press MENU, or wait 30 seconds.

Dimmer Curve

Select **Dimmer Curve**, press ENTER.

Use UP/DOWN button to select **Linear**, **Square Law**, **Inv SQ Law** or **S Curve**, confirm your selection with ENTER.

Dimmer Modes

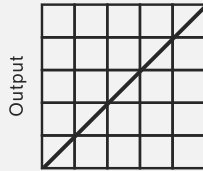

Optically Linear

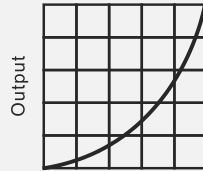

Square Law

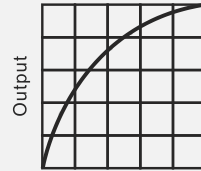

Inverse Square Law

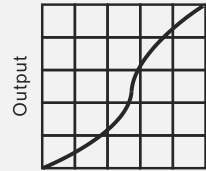

S-curve

To exit the menu, press MENU, or wait 30 seconds.

Cooling Mode

Select **Cooling Mode**, press ENTER.

Use UP/DOWN button to select **Standard** or **Quiet**, confirm your selection with ENTER.

To exit the menu, press MENU, or wait 30 seconds.

Led Refresh Rate

Select **Led Refresh Rate**, press ENTER.

Use UP/DOWN button to select **900Hz**, **1000Hz**, **1100Hz**, **1200Hz**, **1300Hz**, **1400Hz**, **1500Hz**, **2500Hz**, **4000Hz**, **5000Hz**, **6000Hz**, **10KHz**, **15KHz**, **20KHz** or **25KHz**, confirm your selection with ENTER.

To exit the menu, press MENU, or wait 30 seconds.

Blade Mode

Select **Blade Mode**, press ENTER.

Use UP/DOWN button to select **Mode 1** or **Mode 2**, confirm your selection with ENTER.

To exit the menu, press MENU, or wait 30 seconds.

Gobo Short Cut

Select **Gobo Short Cut**, press ENTER.

Use UP/DOWN button to select **Enable** or **Disable**, confirm your selection with ENTER.

To exit the menu, press MENU, or wait 30 seconds.

Color Short Cut

Select **Color Short Cut**, press ENTER.

Use UP/DOWN button to select **Enable** or **Disable**, confirm your selection with ENTER.

To exit the menu, press MENU, or wait 30 seconds.

Display Settings

Enter the control menu and select **Display Settings**, press ENTER. Use the UP/DOWN button to select **Display Invert**, **Backlight Intensity**, **Temperature Unit** or **Language**.

Display Invert

Select **Display Invert**, press ENTER.

Use UP/DOWN button to select **No** (display normal) or **Yes** (display inverted), confirm your selection with ENTER.

To exit the menu, press MENU, or wait 30 seconds.

Backlight Intensity

Select **Backlight Intensity**, press ENTER.

Use UP/DOWN button to select a value between **1** (dark) and **10** (bright), confirm your selection with ENTER.

To exit the menu, press MENU, or wait 30 seconds.

Temperature Unit

Select **Temperature Unit**, press ENTER.

Use UP/DOWN button to select **°C** or **°F**, confirm your selection with ENTER.

To exit the menu, press MENU, or wait 30 seconds.

Language

Select **Language**, press ENTER.

Use UP/DOWN button to select **English** or **Chinese**, confirm your selection with ENTER.

To exit the menu, press MENU, or wait 30 seconds.

Fixture Test

Enter the control menu and select **Fixture Test**, press ENTER. Use the UP/DOWN button to select **Auto Test** or **Manual Test**.

Auto Test

Select **Auto Test**, press ENTER.

Use UP/DOWN button to select **Single** (the device immediately performs a single automatic self-test) or **Cycle** (the device immediately performs a cyclic automatic self-test), confirm your selection with ENTER.

To exit the menu, press MENU.

Manual Test

Select **Manual Test**, press ENTER.

Use UP/DOWN button to select the channel for which the manual test is to be performed, confirm your selection with ENTER.

Use UP/DOWN button to select a value, confirm your selection with ENTER.

To exit the menu, press MENU.

(The device returns to its original DMX state after the manual test. The test values are saved automatically when the device is switched off.)

Fixture Information

Enter the control menu and select **Fixture Information**, press ENTER. Use the UP/DOWN button to select **Fixture Use Hour**, **LED Use Hour**, **Temperature**, **Humidity**, **Fan State**, **Firmware Version**, **RDM UID** or **Error Logs**.

Fixture Use Hour

Select **Fixture Use Hour**, press ENTER.
The operating hours is displayed.
To exit the menu, press MENU, or wait 30 seconds.

LED Use Hour

Select **LED Use Hour**, press ENTER.
Use UP/DOWN button to select **Total LED Hour** (total time) or **LED On Hour** (current switch-on time), confirm your selection with ENTER.
The total time or current switch-on time is displayed.
Use UP/DOWN button to select **LED Hours Reset**, confirm your selection with ENTER.
Use UP/DOWN button to set the password 050, confirm your selection with ENTER. The LED operating hours is reset.
To exit the menu, press MENU, or wait 30 seconds.

Temperature

Select **Temperature**, press ENTER.
The device temperature is displayed.
To exit the menu, press MENU, or wait 30 seconds.

Humidity

Select **Humidity**, press ENTER.
The device humidity is displayed.
To exit the menu, press MENU, or wait 30 seconds.

Fan State

Select **Fan State**, press ENTER.

The fan status is displayed.

To exit the menu, press MENU, or wait 30 seconds.

Firmware Version

Select **Firmware Version**, press ENTER.

The firmware version is displayed.

To exit the menu, press MENU, or wait 30 seconds.

RDM UID

Select **RDM UID**, press ENTER.

The RDM UID is displayed.

To exit the menu, press MENU, or wait 30 seconds.

Error Logs

Select **Error Logs**, press ENTER.

Use UP/DOWN button to select **Fixture Errors**, confirm your selection with ENTER.

The error list is displayed.

Use UP/DOWN button to select **Reset Error Log**, confirm your selection with ENTER.

If you wish to reset the relevant error logs, select **Yes**. If you do not wish to reset anything, select **No**. Confirm your selection with ENTER.

If you select **Yes**, use UP/DOWN button to set the password 050, confirm your selection with ENTER. The relevant error logs are reset.

To exit the menu, press MENU, or wait 30 seconds.

Reset Function

Enter the control menu and select **Reset Function**, press ENTER. Use the UP/DOWN button to select **Pan/Tilt Reset**, **Effect Reset** or **All Reset**.

Pan/Tilt Reset

Select **Pan/Tilt Reset**, press ENTER.

Use UP/DOWN button to select **No** or **Yes** (the device will run built-in program to reset pan/tilt to their home positions), confirm your selection with ENTER.

To exit the menu, press MENU, or wait 30 seconds.

Effect Reset

Select **Effect Reset**, press ENTER.

Use UP/DOWN button to select **No** or **Yes** (the device will run built-in program to reset effect to their home positions), confirm your selection with ENTER.

To exit the menu, press MENU, or wait 30 seconds.

All Reset

Select **All Reset**, press ENTER.

Use UP/DOWN button to select **No** or **Yes** (the device will run built-in program to reset all to their home positions), confirm your selection with ENTER.

To exit the menu, press MENU, or wait 30 seconds.

Special Function

Enter the control menu and select **Special Function**, press ENTER. Use the UP/DOWN button to select **USB Upgrade, Send Upgrade, Firmware Restore** or **Factory Settings**.

USB Upgrade

Select **USB Upgrade**, press ENTER.

The upgrade files are displayed. (See the 'Updating Software' section for details.)

To exit the menu, press MENU, or wait 30 seconds.

Send Upgrade

Select **Send Upgrade**, press ENTER.

If you wish to send upgrade files from this fixture to next fixtures to upgrade their firmware, select **Yes**. Once Yes is selected, the display of this fixture will show "**Sending Packet, Please Wait...**" while the display of next fixtures will show "**Upgrading, Please Wait...**". A percentage bar will also be displayed. After the update is complete, fixtures will perform a reset (this can take some time).

If you do not wish to send anything, select **No**. Confirm your selection with ENTER.

To exit the menu, press MENU, or wait 30 seconds.

Firmware Restore

Select **Firmware Restore**, press ENTER.

If you wish to restore fixture's firmware, select **Yes**. Once Yes is selected, the display will show "**Upgrading, Please Wait...**". A percentage bar will also be displayed. After the update is complete, the fixture will perform a reset (this can take some time).

If you do not wish to restore anything, select **No**. Confirm your selection with ENTER.

To exit the menu, press MENU, or wait 30 seconds.

Factory Settings

Select **Factory Settings**, press ENTER.

If you wish to reset the device to the factory settings, select **Yes**. If you do not wish to reset anything, select **No**. Confirm your selection with ENTER.

To exit the menu, press MENU, or wait 30 seconds.

7.2 Updating Software

Only qualified technicians should perform this function! Note all menu settings before updating software! Please note, up to 32 fixtures can be connected together and updated at the same time.

1. Download the software update files from the ACME website.
2. Copy the software files to a compatible USB flash drive.

Note: To avoid the risk of uploading the wrong file to the fixture, make sure that there are no other files on your flash drive.

3. Disconnect DMX and Ethernet connections and power the fixture on.
4. Insert the USB flash drive into the **FIRMWARE UPGRADE** port located on the rear panel of the fixture.
5. Locate **“Special Function”** within the system menu and press ENTER. Scroll to the **“USB Upgrade”** submenu and press ENTER.
6. Two software files will be displayed as downloaded earlier. Highlight the first file and press ENTER. Select **“Yes”** to begin the first of two updating processes. Once Yes is selected, the display will show **“Copying Files, Please Wait...”**. After copying is complete, the display will show **“Upgrading, Please Wait...”**. A percentage bar will also be displayed.
7. After the first update is complete, the fixture will perform a reset (this can take some time).
8. Once the reset is complete, scroll to the **“Special Function”** menu again and press ENTER. Scroll to the **“USB Upgrade”** submenu and press ENTER.
9. Highlight the second file this time and press ENTER. Select **“Yes”** to begin the second and final updating process. Once Yes is selected, the display will show **“Copying Files, Please Wait...”** again. After copying is complete, the display will show **“Upgrading, Please Wait...”**. A percentage bar will also be displayed.
10. After the second update is complete, the fixture will perform another reset (this can take some time as well).
11. Remove the USB flash drive.
12. After the reset process is complete, check the new software version to confirm it is updated to the most recent software.

RDM functions: Certain menus of the device and functions can be called up via the RDM protocol.

The parameter IDs are implemented as follows for different commands:

Parameter ID	Command 'Discovery'	Command 'Set'	Command 'Get'
DISC_UNIQUE_BRANCH	✓		
DISC_MUTE	✓		
DISC_UN_MUTE	✓		
DEVICE_INFO			✓
SUPPORTED_PARAMETERS			✓
SOFTWARE_VERSION_LABEL			✓
DMX_START_ADDRESS		✓	✓
IDENTIFY_DEVICE		✓	✓
DEVICE_MODEL_DESCRIPTION			✓
PARAMETER_DESCRIPTION			✓
MANUFACTURER_LABEL			✓
DEVICE_LABEL		✓	✓
FACTORY_DEFAULTS		✓	✓
BOOT_SOFTWARE_VERSION_ID			✓
BOOT_SOFTWARE_VERSION_LABEL			✓
DMX_PERSONALITY		✓	✓
DMX_PERSONALITY_DESCRIPTION			✓
SLOT_INFO			✓
SLOT_DESCRIPTION			✓
SENSOR_DEFINITION			✓
SENSOR_VALUE			✓
DEVICE_HOURS			✓
LAMP_HOURS			✓
PAN_INVERT		✓	✓
TILT_INVERT		✓	✓
RESET_DEVICE		✓	
CURVE		✓	✓
DMX_STATE		✓	✓
DIMMER_SPEED		✓	✓

✓ -Command implemented for the respective parameter ID

7.3 Home Position Adjustment

- ▶ To access the control menus, press the [MENU] button.
- ▶ To access the offset menus, long-press the [ENTER] button.
- ▶ Navigate the offset menus, using the [ENTER], [▲ UP] and [▼ DOWN] buttons.
- ▶ To select a menu option or to confirm a selection, press the [ENTER] button.
- ▶ To return to a higher level in the menu structure without making a change, press the [MENU] button, or wait 30 seconds.

OFFSET MENU	VALUES
Frequency(Hz)	1072~1327
Dimming Start	0~255
Dim 1 Offset	-128~127
.....
Dim 4 Offset	-128~127
Pan	-128~127
Tilt	-128~127
Cyan	-128~127
Magenta	-128~127
Yellow	-128~127
CTO	-128~127
Color	-128~127
Gobo 1	-128~127
R-Gobo 1	-128~127
Gobo 2	-128~127
Animation	-128~127
Iris	0~255
Prism 1	-128~127
R-Prism 1	-128~127
Prism 2	-128~127
R-Prism 2	-128~127
Frost 1	-128~127
Frost 2	-128~127
Zoom	-128~127
Focus	-128~127
Blade	-128~127

Blade DW 1	-128~127
Blade DW 2	-128~127
Blade UP 1	-128~127
Blade UP 2	-128~127
Blade LF 1	-128~127
Blade LF 2	-128~127
Blade RG 1	-128~127
Blade RG 2	-128~127

Frequency(Hz)

Select **Frequency(Hz)**, press ENTER.

Use UP/DOWN button to select a value, confirm your selection with ENTER.

To exit the offset menu, press MENU, or wait 30 seconds.

Frequency	VALUES
900Hz	772~1027
1000Hz	872~1127
1100Hz	972~1227
1200Hz	1072~1327
1300Hz	1172~1427
1400Hz	1272~1527
1500Hz	1372~1627
2500Hz	2372~2627
4000Hz	3872~4127
5000Hz	4872~5127
6000Hz	5872~6127
10KHz	9872~10127
15KHz	14872~15127
20KHz	19872~20127
25KHz	24872~25127

Dimming Start

Select **Dimming Start**, press ENTER.

Use UP/DOWN button to select a value between 0 and 255, confirm your selection with ENTER.

To exit the offset menu, press MENU, or wait 30 seconds.

Dim 1 Offset

Select **Dim 1 Offset**, press ENTER.

Use UP/DOWN button to select a value between -128 and 127, confirm your selection with ENTER.

To exit the offset menu, press MENU, or wait 30 seconds.

.....

Dim 4 Offset

Select **Dim 4 Offset**, press ENTER.

Use UP/DOWN button to select a value between -128 and 127, confirm your selection with ENTER.

To exit the offset menu, press MENU, or wait 30 seconds.

Pan

Select **Pan**, press ENTER.

Use UP/DOWN button to select a value between -128 and 127, confirm your selection with ENTER.

To exit the offset menu, press MENU, or wait 30 seconds.

Tilt

Select **Tilt**, press ENTER.

Use UP/DOWN button to select a value between -128 and 127, confirm your selection with ENTER.

To exit the offset menu, press MENU, or wait 30 seconds.

Cyan

Select **Cyan**, press ENTER.

Use UP/DOWN button to select a value between -128 and 127, confirm your selection with ENTER.

To exit the offset menu, press MENU, or wait 30 seconds.

Magenta

Select **Magenta**, press ENTER.

Use UP/DOWN button to select a value between -128 and 127, confirm your selection with ENTER.

To exit the offset menu, press MENU, or wait 30 seconds.

Yellow

Select **Yellow**, press ENTER.

Use UP/DOWN button to select a value between -128 and 127, confirm your selection with ENTER.

To exit the offset menu, press MENU, or wait 30 seconds.

CTO

Select **CTO**, press ENTER.

Use UP/DOWN button to select a value between -128 and 127, confirm your selection with ENTER.

To exit the offset menu, press MENU, or wait 30 seconds.

Color

Select **Color**, press ENTER.

Use UP/DOWN button to select a value between -128 and 127, confirm your selection with ENTER.

To exit the offset menu, press MENU, or wait 30 seconds.

Gobo 1

Select **Gobo 1**, press ENTER.

Use UP/DOWN button to select a value between -128 and 127, confirm your selection with ENTER.

To exit the offset menu, press MENU, or wait 30 seconds.

R-Gobo 1

Select **R-Gobo 1**, press ENTER.

Use UP/DOWN button to select a value between -128 and 127, confirm your selection with ENTER.

To exit the offset menu, press MENU, or wait 30 seconds.

Gobo 2

Select **Gobo 2**, press ENTER.

Use UP/DOWN button to select a value between -128 and 127, confirm your selection with ENTER.

To exit the offset menu, press MENU, or wait 30 seconds.

Animation

Select **Animation**, press ENTER.

Use UP/DOWN button to select a value between -128 and 127, confirm your selection with ENTER.

To exit the offset menu, press MENU, or wait 30 seconds.

Iris

Select **Iris**, press ENTER.

Use UP/DOWN button to select a value between 0 and 255, confirm your selection with ENTER.

To exit the offset menu, press MENU, or wait 30 seconds.

Prism 1

Select **Prism 1**, press ENTER.

Use UP/DOWN button to select a value between -128 and 127, confirm your selection with ENTER.

To exit the offset menu, press MENU, or wait 30 seconds.

R-Prism 1

Select **R-Prism 1**, press ENTER.

Use UP/DOWN button to select a value between -128 and 127, confirm your selection with ENTER.

To exit the offset menu, press MENU, or wait 30 seconds.

Prism 2

Select **Prism 2**, press ENTER.

Use UP/DOWN button to select a value between -128 and 127, confirm your selection with ENTER.

To exit the offset menu, press MENU, or wait 30 seconds.

R-Prism 2

Select **R-Prism 2**, press ENTER.

Use UP/DOWN button to select a value between -128 and 127, confirm your selection with ENTER.

To exit the offset menu, press MENU, or wait 30 seconds.

Frost 1

Select **Frost 1**, press ENTER.

Use UP/DOWN button to select a value between -128 and 127, confirm your selection with ENTER.

To exit the offset menu, press MENU, or wait 30 seconds.

Frost 2

Select **Frost 2**, press ENTER.

Use UP/DOWN button to select a value between -128 and 127, confirm your selection with ENTER.

To exit the offset menu, press MENU, or wait 30 seconds.

Zoom

Select **Zoom**, press ENTER.

Use UP/DOWN button to select a value between -128 and 127, confirm your selection with ENTER.

To exit the offset menu, press MENU, or wait 30 seconds.

Focus

Select **Focus**, press ENTER.

Use UP/DOWN button to select a value between -128 and 127, confirm your selection with ENTER.

To exit the offset menu, press MENU, or wait 30 seconds.

Blade

Select **Blade**, press ENTER.

Use UP/DOWN button to select a value between -128 and 127, confirm your selection with ENTER.

To exit the offset menu, press MENU, or wait 30 seconds.

Blade DW1

Select **Blade DW 1**, press ENTER.

Use UP/DOWN button to select a value between -128 and 127, confirm your selection with ENTER.

To exit the offset menu, press MENU, or wait 30 seconds.

Blade DW 2

Select **Blade DW 2**, press ENTER.

Use UP/DOWN button to select a value between -128 and 127, confirm your selection with ENTER.

To exit the offset menu, press MENU, or wait 30 seconds.

Blade UP 1

Select **Blade UP 1**, press ENTER.

Use UP/DOWN button to select a value between -128 and 127, confirm your selection with ENTER.

To exit the offset menu, press MENU, or wait 30 seconds.

Blade UP 2

Select **Blade UP 2**, press ENTER.

Use UP/DOWN button to select a value between -128 and 127, confirm your selection with ENTER.

To exit the offset menu, press MENU, or wait 30 seconds.

Blade LF 1

Select **Blade LF 1**, press ENTER.

Use UP/DOWN button to select a value between -128 and 127, confirm your selection with ENTER.

To exit the offset menu, press MENU, or wait 30 seconds.

Blade LF 2

Select **Blade LF 2**, press ENTER.

Use UP/DOWN button to select a value between -128 and 127, confirm your selection with ENTER.

To exit the offset menu, press MENU, or wait 30 seconds.

Blade RG 1

Select **Blade RG 1**, press ENTER.

Use UP/DOWN button to select a value between -128 and 127, confirm your selection with ENTER.

To exit the offset menu, press MENU, or wait 30 seconds.

Blade RG 2

Select **Blade RG 2**, press ENTER.

Use UP/DOWN button to select a value between -128 and 127, confirm your selection with ENTER.

To exit the offset menu, press MENU, or wait 30 seconds.

08/ Configuring the Device for DMX Control

8.1 Address Setting

All fixtures should be given a DMX starting address when operating with a DMX controller, in order to ensure that the correct fixture responds to the correct control signal. Incorrect settings will result in unpredictable responses from the lighting controller.

You can set the same starting address for all fixtures or a group of fixtures, or set different addresses for each individual fixture.

Setting all fixtures to the same DMX address will cause all fixtures to react in the same way. In this case, please note that changing the settings of one channel will affect all the fixtures simultaneously.

If you set each fixture to a different DMX address, each unit will “listen” starting at the channel number you have set, based on the quantity of DMX channels of each fixture. That means changing the settings of one channel will only affect the selected fixture.

For example, if the first fixture is set to 40 ch DMX mode with a start DMX address of 1, the following fixture in the DMX chain should then be set to a DMX address of 41. As the first fixture uses all the first 40 DMX channels, the next available channel is 41 ($40+1=41 >> 41$).

See the chart below for more details:

Channel Mode	Unit 1 Address	Unit 2 Address	Unit 3 Address	Unit 4 Address
40 channels	1	41	81	121
31 channels	1	32	63	94
31 channels	1	32	63	94
22 channels	1	23	45	67

8.2 DMX Protocol

CHANNEL				VALUE	FUNCTION
40ch Framing	31ch F-Wash	31ch Spot	22ch Wash		
1	1	1	1	000-255	PAN 0°→540°
2	2	2	2	000-255	PAN FINE
3	3	3	3	000-255	TILT 0°→260°
4	4	4	4	000-255	TILT FINE
5	5	5	5	000-255	PAN/TILT SPEED Fast to Slow
6	6	6	6	000-255	CYAN 0%→100%
7	7	7	7	000-255	MAGENTA 0%→100%
8	8	8	8	000-255	YELLOW 0%→100%
9	9	9	9	000-255	CTO 0%→100%
10	10	10	10	000-007	COLOR WHEEL Open
				008-018	Color 1
				019-029	Color 2
				030-040	Color 3
				041-051	Color 4
				052-063	Color 5
				064-066	Open
				067-069	Open + Color 1
				070-072	Color 1
				073-075	Color 1 + Color 2
				076-078	Color 2
				079-081	Color 2 + Color 3
				082-084	Color 3
				085-087	Color 3 + Color 4
088-090	Color 4				
091-093	Color 4 + Color 5				
094-096	Color 5				
097-099	Color 5 + CRI				
100-102	CRI				
103-105	CRI + CTB				
106-108	CTB				
109-111	CTB + Open				

				112-127 128-189 190-193 194-255	Open Counter-Clockwise Rotation, Fast to Slow Stop Clockwise Rotation, Slow to Fast
11		11		000-007 008-014 015-021 022-028 029-035 036-042 043-049 050-056 057-063 064-071 072-079 080-087 088-095 096-103 104-111 112-119 120-127 128-189 190-193 194-255	GOBO WHEEL 1 Open Gobo 1 Gobo 2 Gobo 3 Gobo 4 Gobo 5 Gobo 6 Gobo 7 Gobo 8 Gobo 1 Shaking, Slow to Fast Gobo 2 Shaking, Slow to Fast Gobo 3 Shaking, Slow to Fast Gobo 4 Shaking, Slow to Fast Gobo 5 Shaking, Slow to Fast Gobo 6 Shaking, Slow to Fast Gobo 7 Shaking, Slow to Fast Gobo 8 Shaking, Slow to Fast Counter-Clockwise Rotation, Fast to Slow Stop Clockwise Rotation, Slow to Fast
12		12		000-127 128-189 190-193 194-255	R-GOBO WHEEL 1 Index 0°→360° Counter-Clockwise Rotation, Fast to Slow Stop Clockwise Rotation, Slow to Fast
13		13		000-255	R-GOBO WHEEL 1 FINE 0%→100%
14		14		000-007 008-013 014-019 020-025 026-031 032-037 038-043 044-049 050-055 056-063 064-070 071-077 078-084 085-091	GOBO WHEEL 2 Open Gobo 1 Gobo 2 Gobo 3 Gobo 4 Gobo 5 Gobo 6 Gobo 7 Gobo 8 Gobo 9 Gobo 1 Shaking, Slow to Fast Gobo 2 Shaking, Slow to Fast Gobo 3 Shaking, Slow to Fast Gobo 4 Shaking, Slow to Fast

				092-098 099-105 106-112 113-119 120-127 128-189 190-193 194-255	Gobo 5 Shaking, Slow to Fast Gobo 6 Shaking, Slow to Fast Gobo 7 Shaking, Slow to Fast Gobo 8 Shaking, Slow to Fast Gobo 9 Shaking, Slow to Fast Clockwise Rotation, Fast to Slow Stop Counter-Clockwise Rotation, Slow to Fast
15		15		000-007 008-129 130-133 134-255	ANIMATION Open Counter-Clockwise Rotation, Fast to Slow Stop Clockwise Rotation, Slow to Fast
16	11	16	11	000-255	IRIS 100%→0%
17		17		000-007 008-255	PRISM 1 (4-facet prism) Close Open
18		18		000-127 128-189 190-193 194-255	R-PRISM 1 Index 0°→360° Counter-Clockwise Rotation, Fast to Slow Stop Clockwise Rotation, Slow to Fast
19		19		000-007 008-255	PRISM 2 (4-facet linear prism) Close Open
20		20		000-127 128-189 190-193 194-255	R-PRISM 2 Index 0°→360° Counter-Clockwise Rotation, Fast to Slow Stop Clockwise Rotation, Slow to Fast
21	12	21	12	000-007 008-255	CRI Close Open
22	13	22	13	000-255	FROST1 (Soft) 0%→100%
23	14	23	14	000-255	FROST2 (Heavy) 0%→100%
24	15	24	15	000-255	ZOOM Wide→Narrow
25	16	25	16	000-255	ZOOM FINE
26	17	26	17	000-255	FOCUS 0%→100%
27	18	27	18	000-255	FOCUS FINE

28	19	28	19	000-007 008-015 016-131 132-139 140-181 182-189 190-231 232-239 240-247 248-255	STROBE Close Open Strobe from Slow to Fast Open Fast Open Slow Close from Slow to Fast Open Slow Open Fast Close from Slow to Fast Open Random Strobe from Slow to Fast Open
29	20	29	20	000-255	DIMMER 0%→100%
30	21	30	21	000-255	DIMMER FINE
31	22			000-255	BLADE 0°→180°
32	23			000-255	BLADE DW 1 0%→100%
33	24			000-255	BLADE DW 2 0%→100%
34	25			000-255	BLADE UP 1 0%→100%
35	26			000-255	BLADE UP 2 0%→100%
36	27			000-255	BLADE LF 1 0%→100%
37	28			000-255	BLADE LF 2 0%→100%
38	29			000-255	BLADE RG 1 0%→100%
39	30			000-255	BLADE RG 2 0%→100%
40	31	31	22	000-005 006-007 008-009 010-019 020-029 030-039 040-049 050-059	FUNCTION (To activate following functions, stop in DMX value for at least 3 seconds.) Null Null Null Blade Mode: Mode 1 (Not available on 31 (Spot) ch & 22ch) Blade Mode: Mode 2 (Not available on 31 (Spot) ch & 22ch) Dimmer Curve Square Law Dimmer Curve Inv Square Law Dimmer Curve Linear

			060-069	Dimmer Curve S
			070-079	Cooling Mode: Standard
			080-089	Cooling Mode: Quiet
			090-099	Null
			100-109	LED Frequency Setting Enable
			110-119	LED Frequency Setting Disable
			120-122	Null
			123	900Hz
			124	1000Hz
			125	1100Hz
			126	1200Hz
			127	1300Hz
			128	1400Hz
			129	1500Hz
			130	2500Hz
			131	4000Hz
			132	5000Hz
			133	6000Hz
			134	10KHz
			135	15KHz
			136	20KHz
			137	25KHz
			138-139	Null
			140-149	Reset Pan/Tilt
			150-159	Reset Effect
			160-199	Null
			200-209	Reset All
			210-219	Dimmer Speed: Fast
			220-229	Dimmer Speed: Smooth
			230-231	Gobo Short Cut: Enable (Not available on 31 (F-Wash) ch & 22ch)
			232-233	Gobo Short Cut: Disable (Not available on 31 (F-Wash) ch & 22ch)
			234-235	Color Short Cut: Enable
			236-237	Color Short Cut: Disable
			238-255	Null

09/ Error Information

Error codes are shown continuously in the display when the fixture fails and they will not disappear until the fixture is repaired.

CPU-B/C/D/E/F/G Error

Check whether the 485 (DATA) leads on the PCB board are installed in place or disconnected.

Check whether the related 485 (DATA) signal circuit on the PCB board is damaged.

Pan Reset Error

Check whether the position of the pan where the magnet is installed falls off or is damaged.

Check whether there are obstacles in the pan operating range.

Check whether the Hall element on the pan is damaged.

Check whether the lead connecting the Hall element on the pan and the PCB board is in poor contact or disconnected.

Check whether the motor on the pan is damaged.

Check whether the related circuit of the motor drive board on the pan is damaged.

Pan Encode Error

Check whether the encoder on the pan is damaged.

Check whether the lead connecting the encoder on the pan and the PCB board is in poor contact or disconnected.

Pan Encode No Find

Check whether the lead connecting the encoder on the pan and the PCB board is in poor contact or disconnected.

Pan Encode Disable

Check whether the encoder on the pan is damaged.

Tilt Reset Error

Check whether the position of the tilt where the magnet is installed falls off or is damaged.

Check whether there are obstacles in the tilt operating range.

Check whether the Hall element on the tilt is damaged.

Check whether the lead connecting the Hall element on the tilt and the PCB board is in poor contact or disconnected.

Check whether the motor on the tilt is damaged.

Check whether the related circuit of the motor drive board on the tilt is damage.

Tilt Encode Error

Check whether the encoder on the tilt is damaged.

Check whether the lead connecting the encoder on the tilt and the PCB board is in poor contact or disconnected.

Tilt Encode No Find

Check whether the lead connecting the encoder on the tilt and the PCB board is in poor contact or disconnected.

Tilt Encode Disable

Check whether the encoder on the tilt is damaged.

Cyan Reset Error

Check whether the position of the cyan color wheel where the magnet is installed falls off or is damaged.

Check whether there are obstacles in the cyan color wheel operating range.

Check whether the Hall element on the cyan color wheel is damaged.

Check whether the lead connecting the Hall element on the cyan color wheel and the PCB board is in poor contact or disconnected.

Check whether the motor on the cyan color wheel is damaged.

Check whether the related circuit of the motor drive board on the cyan color wheel is damage.

Magenta Reset Error

Check whether the position of the magenta color wheel where the magnet is installed falls off or is damaged.

Check whether there are obstacles in the magenta color wheel operating range.

Check whether the Hall element on the magenta color wheel is damaged.

Check whether the lead connecting the Hall element on the magenta color wheel and the PCB board is in poor contact or disconnected.

Check whether the motor on the magenta color wheel is damaged.

Check whether the related circuit of the motor drive board on the magenta color wheel is damage.

Yellow Reset Error

Check whether the position of the yellow color wheel where the magnet is installed falls off or is damaged.

Check whether there are obstacles in the yellow color wheel operating range.

Check whether the Hall element on the yellow color wheel is damaged.

Check whether the lead connecting the Hall element on the yellow color wheel and the PCB board is in poor contact or disconnected.

Check whether the motor on the yellow color wheel is damaged.

Check whether the related circuit of the motor drive board on the yellow color wheel is damage.

CTO Reset Error

Check whether the position of the cto where the magnet is installed falls off or is damaged.

Check whether there are obstacles in the cto operating range.

Check whether the Hall element on the cto is damaged.

Check whether the lead connecting the Hall element on the cto and the PCB board is in poor contact or disconnected.

Check whether the motor on the cto is damaged.

Check whether the related circuit of the motor drive board on the cto is damage.

Color Reset Error

Check whether the position of the color wheel where the magnet is installed falls off or is damaged.

Check whether there are obstacles in the color wheel operating range.

Check whether the Hall element on the color wheel is damaged.

Check whether the lead connecting the Hall element on the color wheel and the PCB board is in poor contact or disconnected.

Check whether the motor on the color wheel is damaged.

Check whether the related circuit of the motor drive board on the color wheel is damage.

Gobo 1/2 Reset Error

Check whether the position of the gobo wheel 1/2 where the magnet is installed falls off or is damaged.

Check whether there are obstacles in the gobo wheel 1/2 operating range.

Check whether the Hall element on the gobo wheel 1/2 is damaged.

Check whether the lead connecting the Hall element on the gobo wheel 1/2 and the PCB board is in poor contact or disconnected.

Check whether the motor on the gobo wheel 1/2 is damaged.

Check whether the related circuit of the motor drive board on the gobo wheel 1/2 is damage.

R-Gobo 1 Reset Error

Check whether the position of the gobo wheel 1 where the magnet is installed falls off or is damaged.

Check whether there are obstacles in the gobo wheel 1 operating range.

Check whether the Hall element on the gobo wheel 1 is damaged.

Check whether the lead connecting the Hall element on the gobo wheel 1 and the PCB board is in poor contact or disconnected.

Check whether the motor on the gobo wheel 1 is damaged.

Check whether the related circuit of the motor drive board on the gobo wheel 1 is damage.

Animation Reset Error

Check whether the position of the animation wheel where the magnet is installed falls off or is damaged.

Check whether there are obstacles in the animation wheel operating range.

Check whether the Hall element on the animation wheel is damaged.

Check whether the lead connecting the Hall element on the animation wheel and the PCB board is in poor contact or disconnected.

Check whether the motor on the animation wheel is damaged.

Check whether the related circuit of the motor drive board on the animation wheel is damage.

Prism 1/2 Reset Error

Check whether the position of the prism 1/2 where the magnet is installed falls off or is damaged.

Check whether there are obstacles in the prism 1/2 operating range.

Check whether the Hall element on the prism 1/2 is damaged.

Check whether the lead connecting the Hall element on the prism 1/2 and the PCB board is in poor contact or disconnected.

Check whether the motor on the prism 1/2 is damaged.

Check whether the related circuit of the motor drive board on the prism 1/2 is damage.

R-Prism 1/2 Reset Error

Check whether the position of the prism 1/2 where the magnet is installed falls off or is damaged.

Check whether there are obstacles in the prism 1/2 operating range.

Check whether the Hall element on the prism 1/2 is damaged.

Check whether the lead connecting the Hall element on the prism 1/2 and the PCB board is in poor contact or disconnected.

Check whether the motor on the prism 1/2 is damaged.

Check whether the related circuit of the motor drive board on the prism 1/2 is damage.

Focus Reset Error

Check whether the position of the focus where the magnet is installed falls off or is damaged.

Check whether there are obstacles in the focus operating range.

Check whether the Hall element on the focus is damaged.

Check whether the lead connecting the Hall element on the focus and the PCB board is in poor contact or disconnected.

Check whether the motor on the focus is damaged.

Check whether the related circuit of the motor drive board on the focus is damage.

Zoom Reset Error

Check whether the position of the zoom where the magnet is installed falls off or is damaged.

Check whether there are obstacles in the zoom operating range.

Check whether the Hall element on the zoom is damaged.

Check whether the lead connecting the Hall element on the zoom and the PCB board is in poor contact or disconnected.

Check whether the motor on the zoom is damaged.

Check whether the related circuit of the motor drive board on the zoom is damage.

Blade Reset Error

Check whether the position of the blade where the magnet is installed falls off or is damaged.

Check whether there are obstacles in the blade operating range.

Check whether the Hall element on the blade is damaged.

Check whether the lead connecting the Hall element on the blade and the PCB board is in poor contact or disconnected.

Check whether the motor on the blade is damaged.

Check whether the related circuit of the motor drive board on the blade is damage.

Base Fan1/2 Start Err

Check whether the fan is not running.

Check whether the fan leads are installed in place or disconnected.

Check whether the fan is damaged.

Check whether there are obstacles in the fan operating range.

Arm Fan Start Err

Check whether the fan is not running.

Check whether the fan leads are installed in place or disconnected.

Check whether the fan is damaged.

Check whether there are obstacles in the fan operating range.

Head Fan1/2/3/4/5/6/7/8/9/10 Start Err

Check whether the fan is not running.

Check whether the fan leads are installed in place or disconnected.

Check whether the fan is damaged.

Check whether there are obstacles in the fan operating range.

Led Temp. Error

Check whether the temperature detecting board is normal.

Check whether the components of the temperature detecting board are damaged.

Check whether the lead on the temperature detecting board is installed in place or disconnected.

LED Timeout Use

LED Too Hot Off

When the fixture temperature reaches 85°C, it will automatically turn off to protect the fixture.

Base Humidity Error

Check whether the humidity sensor is faulty.

Check whether the lead connecting the humidity sensor is installed in place or disconnected.

Base Humi. Too High

Disassemble the housing of the fixture to dehumidify.

Memory Error

When the memory IC keeps reporting errors, please replace the motherboard.

10/ Troubleshooting

Problem	Potential cause(s)	Remedies
Fixture does not respond or appears to be off.	No power to the fixture.	Confirm that the power is switched on and cables are plugged in.
	No output from PSU.	Replace the PSU.
Fixture suddenly turned off.	Power was turned off.	Check the power supply, switches and breakers.
Light output cuts out intermittently.	Fixture is too hot.	Check fixture's stored error messages for more information. Allow fixture to cool. Clean fixture. Reduce ambient temperature.
Fixture suddenly stopped responding.	DMX cables were disconnected.	Inspect DMX cables.
Fixture operates irregularly / abnormal.	Incorrect DMX address or DMX mode.	Inspect and enter the correct DMX address or mode.
	DMX link is not terminated.	Install a XLR 120ohm DMX termination at the end of the DMX link.
	Bad data link.	Replace or repair defective cables and/or connections.
	One of the fixtures is defective and is disturbing data transmission on the link.	Track and isolate the corrupted fixture. Have the fixture serviced by a qualified technician.
Pan / tilt is skipping / shuddering	Pan/ tilt locks are not released.	Release the pan / tilt locks.
	Obstacles are within the required pan / tilt clearance.	Inspect and remove any obstacles constraining free operation of the pan / tilt.
	The Hall element is damaged.	Replace the Hall element.
	The magnetic steel fell out.	Replace the magnetic steel.

11/ Fixture Cleaning

Regular cleaning is very important for fixture life and performance. Buildup of dust, dirt, smoke particles, fog fluid residues, etc. degrades the fixture's light output and cooling ability. Cleaning schedules for lighting fixtures vary greatly depending on the operating environment. It is therefore impossible to specify precise cleaning intervals for the fixture. Environmental factors that may result in a need for frequent cleaning include:

- ▶ Use of smoke or fog machines.
- ▶ High airflow rates (near air conditioning vents, for example).
- ▶ Airborne dust (from stage effects, building structures and fittings or the natural environment at outdoor events, for example).

If one or more of these factors is present, inspect fixtures within their first few hours of operation to see whether cleaning is necessary. Check again at frequent intervals. This procedure will allow you to assess cleaning requirements in your particular situation.

Follow these precautions when cleaning the fixture:

- ▶ Work in a clean, dry, well-lit area.
- ▶ Use gentle pressure only. A soft lint-free cloth dampened with a solution of water and a mild detergent is recommended, under no circumstances should alcohol, solvents or abrasives be used! Use care when cleaning optical components: surfaces are fragile and easily scratched.

12/ Approvals and Certifications

This product has been tested and found to comply with the following standards:

- 2014/30/EU - Electromagnetic Compatibility (EMC)
- 2014/35/EU - Low Voltage Directive (LVD)
- cETLus Approved (Control #5000057)
- UK SI 2016 No. 1091: Electromagnetic Compatibility Regulations 2016
- UK SI 2016 No. 1101: The Electric Equipment (Safety) Regulations 2016



The information in this document is subject to change without notice.

For the latest information, visit www.acmelighting.com.



www.acmelighting.com