

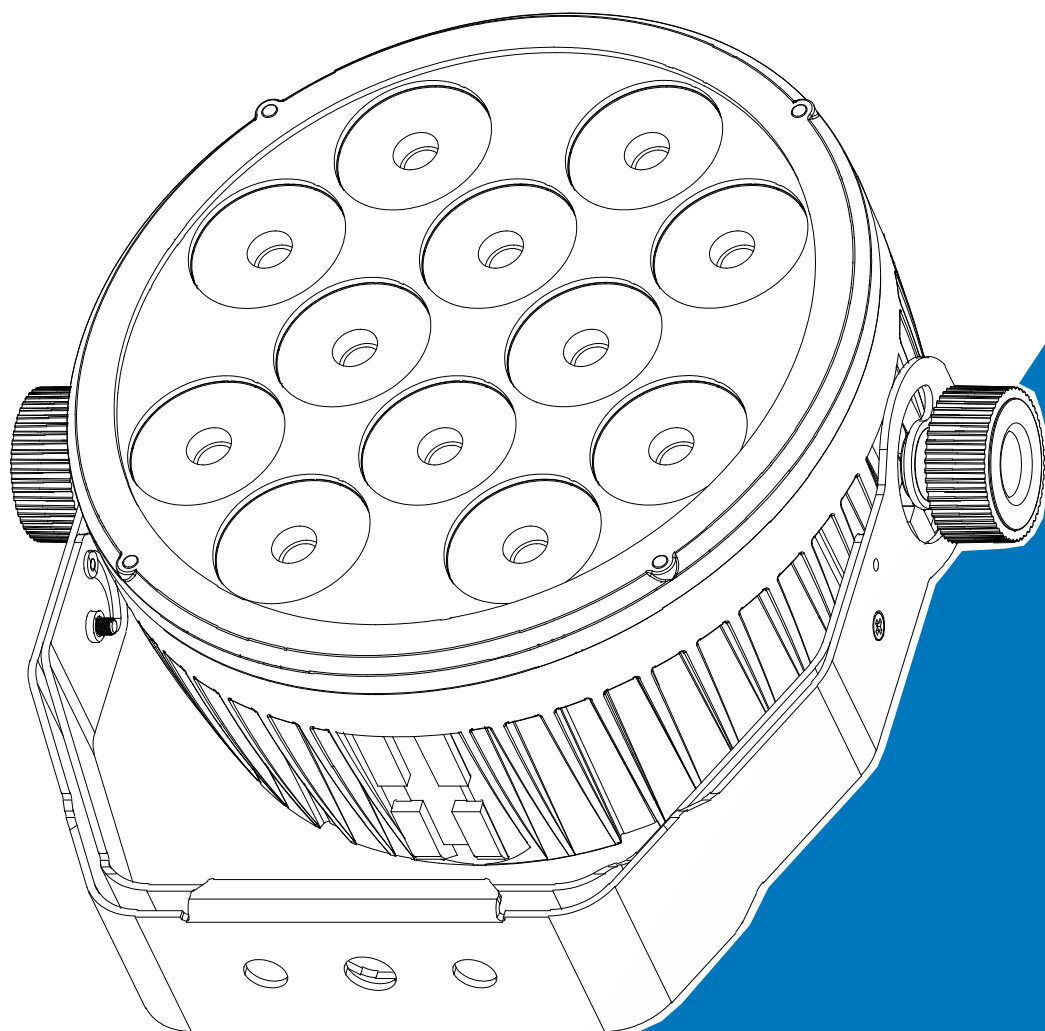

PASODOBLE



User Manual

Please read the instruction carefully before use

CONTENTS

1. Safety Instructions	2
2. Technical Specifications	4
3. Control Panel	5
4. Installation	6
5. How To Set The Unit.....	7
5.1 Main Function.....	7
5.2 Home Position Adjustment	12
6. Control By Universal DMX Controller	14
6.1 DMX512 Connection	14
6.2 Address Setting	15
6.3 DMX512 Configuration.....	15
7. Error Information	21
8. Troubleshooting.....	21
9. Fixture Cleaning	22

1. Safety Instructions



Please read the instruction carefully which includes important information about the installation, usage and maintenance.

WARNING

Please keep this User Guide for future consultation. If you sell the unit to another user, be sure that they also receive this instruction manual.

Important:

Damages caused by the disregard of this user manual are not subject to warranty. The dealer will not accept liability for any resulting defects or problems.

- Unpack and check carefully to ensure that there is no transportation damage before using the unit.
- This product is for indoor use only. Use only in a dry location.
- DO install and operate by qualified operator.
- DO NOT allow children to operate the fixture.
- Use safety chain when fixing the unit. Handle the unit by carrying its base instead of head only.
- The unit must be installed in a location with adequate ventilation, at least 50cm from adjacent surfaces.
- Be sure that no ventilation slots is blocked, otherwise the unit will be overheated.
- Before operation, ensure that you are connecting this product to the proper voltage in accordance with the specifications in this manual or on the product's specification label.
- It's important to ground the yellow/green conductor to earth in order to avoid electric shock.
- Minimum ambient temperature TA: 0°C. Maximum ambient temperature TA: 40°C. Do not operate this product at a lower or higher temperature.
- DO NOT connect the device to any dimmer pack.
- Keep flammable materials away from the fixture while operating to avoid fire hazard.
- Make sure the power cord is not crimped or damaged; replace it immediately if damaged.
- Unit's surface temperature may reach up to 75°C. DO NOT touch the housing bare-handed during its operation.
- Avoid any flammable liquids, water or metal from entering the unit. Once it happens, cut off the mains power immediately.

- DO NOT operate in a dirty or dusty environment. DO clean the fixture regularly.
- DO NOT touch any wire during operation as there might be a hazard of electric shock.
- Avoid entanglement of the power cord with other wires.
- The minimum distance to objects/surface must be more than 0.5 meters.
- In the event of serious operating problem, stop using the unit immediately.
- Never turn on and off the unit time after time.
- The housing, the lenses, or the ultraviolet filter must be replaced if they are visibly damaged.
- DO NOT open the housing as there are no user serviceable parts inside.
- DO NOT attempt to operate this unit if it becomes damaged. DO NOT attempt any repairs yourself. Repairs carried out by unskilled people can lead to damage or malfunction. Please contact the nearest authorized technical assistance center if needed.
- Disconnect this product from its power source before servicing.
- DO use the original packaging if the device is to be transported.
- Avoid direct eye exposure to the light source while the product is on.
- DO NOT operate this product if you see damage on the housing, shields, or cables. Have the damaged parts replaced by an authorized technician at once.

Installation:

The fixture should be fixed on the clamp. Always ensure that the unit is firmly fixed to avoid vibration and slipping off during operation. Ensure that the trussing or area of installation must be able to hold 10 times the weight without any deformation. Always install a safety cable that can hold at least 12 times the weight of the fixture when installing.

DO install and operate by qualified operator. It must be installed in a place where there is out of the reach of people.

2. Technical Specifications

Power Voltage:

100-240V~ 50/60Hz

Power Consumption:

85W

Light Source:

12x8W RGBW LED

Beam Angle:

14°

Field Angle:

25°

Control:

DMX Channel: 10/8/5/4 Channel

Control Mode: DMX512, RDM

Firmware Upgrade via DMX link

Construction:

Display: OLED display

Data In/Out: 3-pin XLR (5-pin XLR is optional)

Power In/Out: Power Connector in/out

Protection Rating: IP20

Features:

Outstanding color mixing effect

Compact design, small size

Smooth dimming from 0-100%

Multiple units can be split-jointed horizontally and vertically with buckle design

Dimension/Weight:

257x88x239mm, 3.3kgs

10.1"x3.5"x9.4" in, 7.3lbs

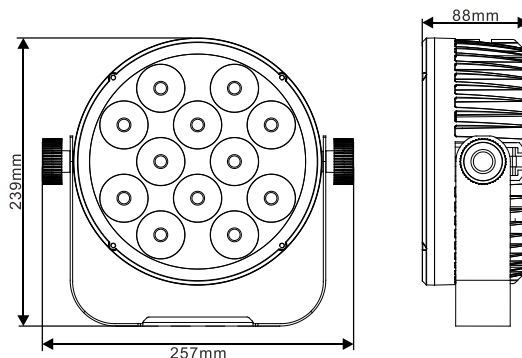

Photometric Diagram:

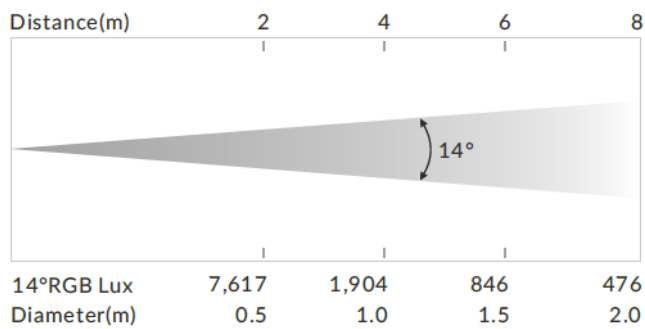

3. Control Panel

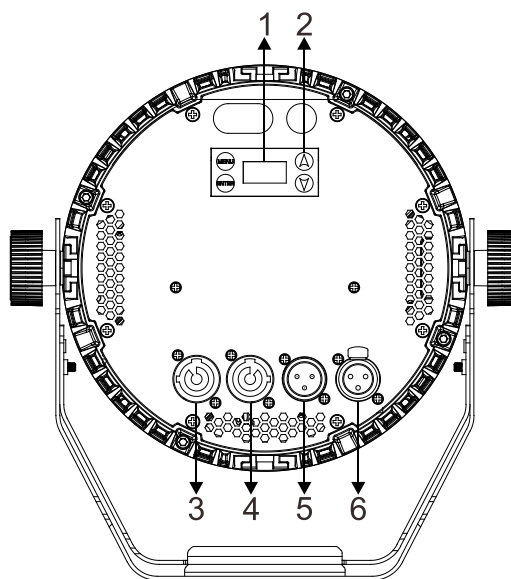

1. Display: To show the various menus and the selected function

2. Button:

MENU	To enter into move backward or leave the menu
▲ UP	To go backward to move up in the menu
▼ DOWN	To go forward to move down in the menu
ENTER	To perform the desired functions

3. POWERCON IN: To connect to supply power

4. POWERCON OUT: To connect to the next fixture

5. DMX IN:

For DMX512 link, use 3-pin XLR cable to link the unit and DMX controller (5-pin XLR is optional)

6. DMX OUT:

For DMX512 link, use 3-pin XLR cable to link the next units (5-pin XLR is optional)

4. Installation

Multiple units can be split-jointed horizontally and vertically with tool-free junction buckle design:

1. As shown in the figure, press and hold the spring pillar on the catch to eject the fixed plate, then align the chute of the luminaire with the chute of the catch. Push the luminaire into the catch before releasing the spring pillar.

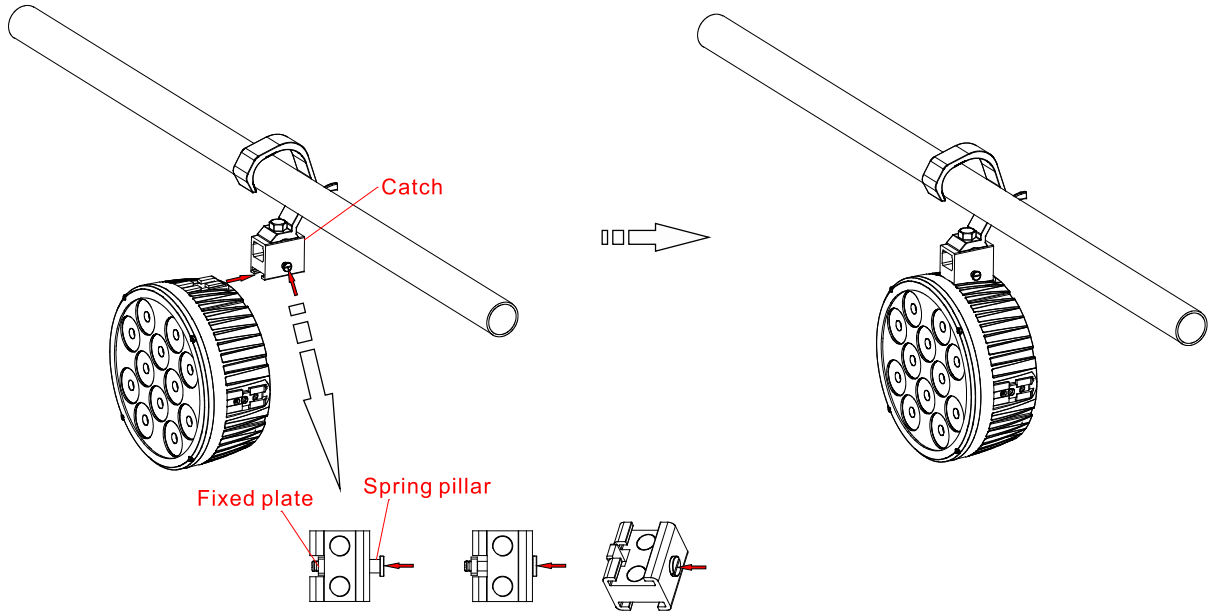

2. The remaining luminaires can be spliced horizontally and vertically as described above.

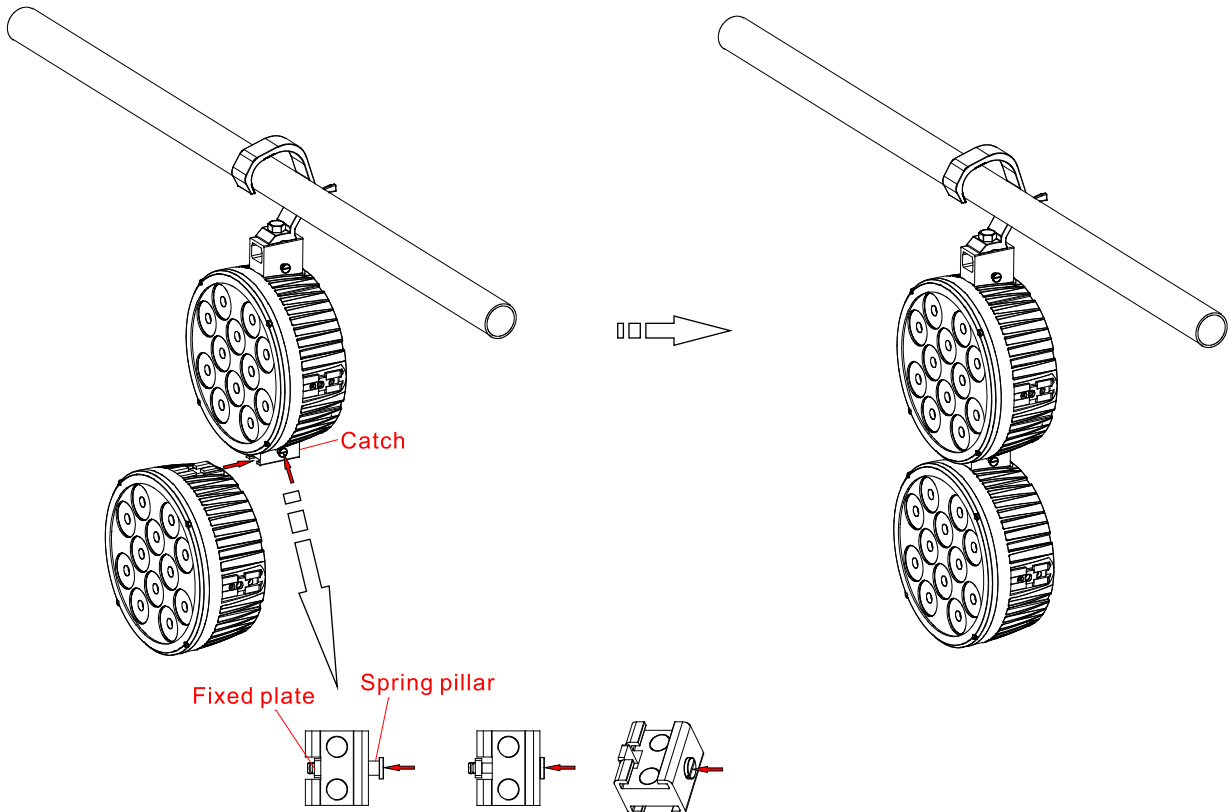

5. How To Set The Unit

5.1 Main Function

Turn on the unit, press the MENU button into menu mode, and press the UP/DOWN button until the required function is shown on the monitor. Select the function by pressing the ENTER button. Use the UP/DOWN button to choose the submenu, press the ENTER button to store and automatically return to the last menu. Press the MENU button or let the unit idle 30 seconds to exit menu mode.

The main functions are shown below:

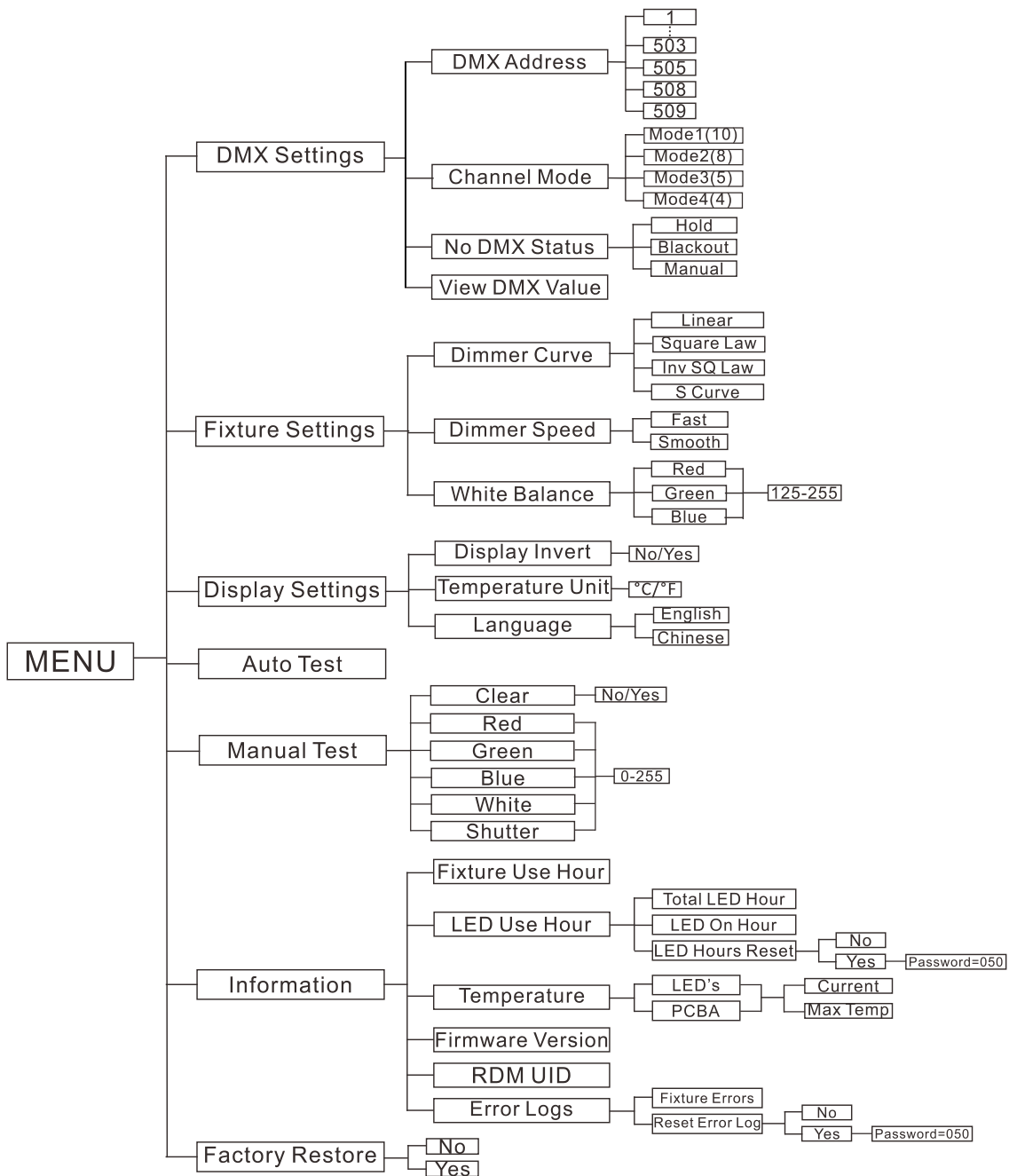

DMX Settings

To select **DMX Settings**, press the **ENTER** button to confirm, use the **UP/DOWN** button to select **DMX Address, Channel Mode, No DMX Status** or **View DMX Value**.

DMX Address

To select **DMX Address**, press the **ENTER** button to confirm. Use the **UP/DOWN** button to adjust the address from **001** to **503/505/508/509**, press the **ENTER** button to store. Press the **MENU** button back to the last menu or let the unit idle 30 seconds to exit menu mode.

Channel Mode

To select **Channel Mode**, press the **ENTER** button to confirm. Use the **UP/DOWN** button to select **Mode1(10), Mode2(8), Mode3(5)** or **Mode4(4)**, press the **ENTER** button to store. Press the **MENU** button back to the last menu or let the unit idle 30 seconds to exit menu mode.

No DMX Status

To select **No DMX Status**, press the **ENTER** button to confirm. Use the **UP/DOWN** button to select **Hold**(fixture continues to obey the last command it received Via DMX if DMX signal stops), **Blackout**(fixture blacks out if DMX signal stops) or **Manual**(the fixture will automatically read the DMX value in the “Manual Test” menu for operation after selecting this mode), press the **ENTER** button to store. Press the **MENU** button back to the last menu or let the unit idle 30 seconds to exit menu mode.

View DMX Value

To select **View DMX Value**, press the **ENTER** button to confirm. Use the **UP/DOWN** button to view the DMX channel value. Press the **MENU** button back to the last menu or let the unit idle 30 seconds to exit menu mode.

Fixture Settings

To select **Fixture Settings**, press the **ENTER** button to confirm, use the **UP/DOWN** button to select **Dimmer Curve, Dimmer Speed** or **White Balance**.

Dimmer Curve

To select **Dimmer Curve**, press the **ENTER** button to confirm. Use the **DOWN/UP** button to select **Linear, Square Law, Inv SQ Law** or **S Curve**, press the **ENTER** button to store. Press the **MENU** button back to the last menu or let the unit idle 30 seconds to exit menu mode.

Dimmer Modes

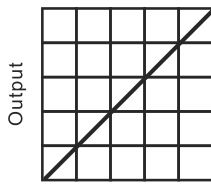

Optically Linear

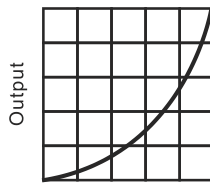

Square Law

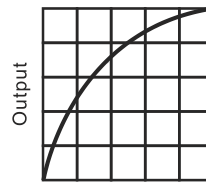

Inverse Square Law

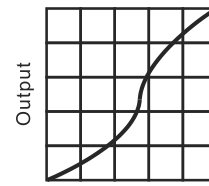

S-curve

Optically Linear: The increase in light intensity appears to be linear as DMX value is increased.

Square Law: Light intensity control is finer at low levels and coarser at high levels.

Inverse Square Law: Light intensity control is coarser at low levels and finer at high levels.

S-Curve: Light intensity control is finer at low levels and high levels and coarser at medium levels.

Dimmer Speed

To select **Dimmer Speed**, press the **ENTER** button to confirm. Use the **UP/DOWN** button to select **Fast** or **Smooth**, press the **ENTER** button to store. Press the **MENU** button back to the last menu or let the unit idle 30 seconds to exit menu mode.

White Balance

To select **White Balance**, press the **ENTER** button to confirm. Use the **UP/DOWN** button to select **Red**, **Green** or **Blue**, press the **ENTER** button to store. Use the **UP/DOWN** button to adjust the value from **125** to **255**, press the **ENTER** button to store. Press the **MENU** button back to the last menu or let the unit idle 30 seconds to exit menu mode.

Display Settings

To select **Display Settings**, press the **ENTER** button to confirm, use the **UP/DOWN** button to select **Display Invert**, **Temperature Unit** or **Language**.

Display Invert

Select **Display Invert**, press the **ENTER** button to confirm, present mode will blink on the display, use the **UP/DOWN** button to select **No** (normal display) or **Yes** (invert display), press the **ENTER** button to store. Press the **MENU** button back to the last menu or let the unit idle 30 seconds to exit menu mode.

Temperature Unit

Select **Temperature Unit**, press the **ENTER** button to confirm. Use the **UP/DOWN** button to select **°C** or **°F**, press the **ENTER** button to store. Press the **MENU** button back to the last menu or let the unit idle 30 seconds to exit menu mode.

Language

Select **Language**, press the **ENTER** button to confirm, present mode will blink on the display, use the **UP/DOWN** button to select **English** or **Chinese**. Press the **MENU** button back to the last menu or let the unit idle 30 seconds to exit menu mode.

Auto Test

To select **Auto Test**, press the **ENTER** button to confirm, the unit will run built-in programs to automatically test its functions. Press the **MENU** button back to the last menu or exit menu mode after auto test.

Manual Test

To select **Manual Test**, press the **ENTER** button to confirm, use the **UP/DOWN** button to select **Clear, Red, Green, Blue, White** or **Shutter**, press the **ENTER** button to confirm, use the **UP/DOWN** button to adjust the value from **0** to **255**, press the **ENTER** button to store. Press the **MENU** button back to the last menu or let the unit idle 30 seconds to exit menu mode.

Information

To select **Information**, press the **ENTER** button to confirm, use the **UP/DOWN** button to select **Fixture Use Hour, LED Use Hour, Temperatue, Firmware Version, RDM UID** or **Error Logs**.

Fixture Use Hour

Select **Fixture Use Hour**, press the **ENTER** button to confirm, fixture use hour will show on the display, press the **MENU** button to exit.

LED Use Hour

To select **LED Use Hour**, press the **ENTER** button to confirm, use the **UP/DOWN** button to select **Total LED Hour, LED On Hour** or **LED Hours Reset**, press the **ENTER** button to store. To select **LED Hours Reset**, press the **ENTER** button to confirm. Use the **UP/DOWN** button to select **No** or **Yes**, press the **ENTER** button to confirm. To select **Yes**, press the **ENTER** button to confirm, use the **UP/DOWN** button to set the password **050** to reset the LED hours, press the **ENTER** button to store. Press the **MENU** button back to the last menu or exit menu mode let the unit idle 30 seconds.

Temperature

Select **Temperature**, press the **ENTER** button to confirm, use the **UP/DOWN** button to select **LED's** or **PCBA**, press the **ENTER** button to confirm, fixture's current temperature and max temperature of the LED or PCBA will show on the display, press the **MENU** button to exit.

Firmware Version

Select **Firmware Version**, press the **ENTER** button to confirm, firmware version will show on the display, press the **MENU** button back to exit.

RDM UID

Select **RDM UID**, press the **ENTER** button to confirm, RDM UID will show on the display, press the **MENU** button back to exit.

Error Logs

Select **Error Logs**, press the **ENTER** button to confirm. Use the **UP/DOWN** button to select **Fixture Errors** or **Reset Error Log**, press the **ENTER** button to store. Select **Reset Error Log**, press the **ENTER** button to confirm. Use the **UP/DOWN** button to select **No** or **Yes**, press the **ENTER** button to store. Select **Yes**, press the **ENTER** button to confirm. Use the **UP/DOWN** button to set the password **050**, press the **ENTER** button to store. Press the **MENU** button back to the last menu or let the unit idle 30 seconds to exit menu mode.

Factory Restore

Select **Factory Restore**, press the **ENTER** button to confirm, use the **UP/DOWN** button to select **No** (normal) or **Yes** (the fixture will reset to factory settings), press **ENTER** button to store. Press the **MENU** button to exit.

RDM FUNCTIONS

Select the MANUFACTURER menu to display the manufacturer of the fixture.

Select the SOFTWARE VERSION menu and the program version number of the fixture will be displayed.

Select the DMX START ADDRESS menu to change the DMX 512 address (001-512).

Select the DEVICE MODEL DESCRIPTION menu to display the model of the fixture.

Select the DEVICE LABEL menu to change the model of the fixture.

Select the DMX PERSONALITY menu to set the channel mode of the fixture (10/8/5/4 channel).

Select the DMX PERSONALITY DESCRIPTION menu to display the current channel mode of the fixture.

Select the DEVICE HOURS menu to display the running time of the fixture.

Select the RESET DEVICE menu, the WARM RESET/COLD RESET option will be displayed. When WARM RESET is selected, the fixture will start a warm reset, and exit when COLD RESET is selected.

5.2 Home Position Adjustment

Press the MENU button into menu mode, then press the ENTER button for about 3 seconds into offset mode to adjust the home position. Select the function by pressing the ENTER button. Use the UP/DOWN button to choose the submenu, press the ENTER button to store and automatically return to the last menu. Press MENU button to exit.

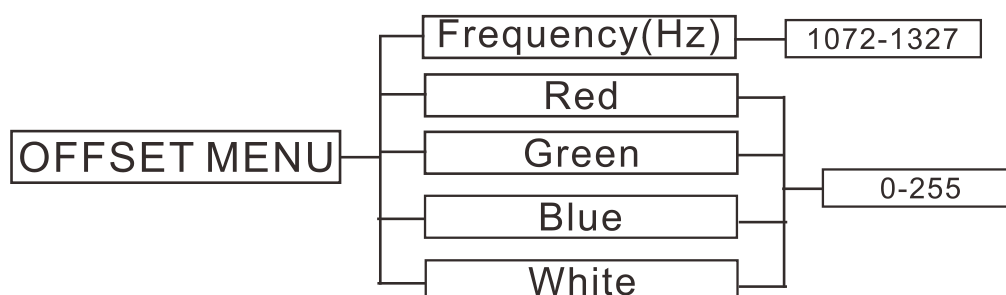

Frequency(Hz)

Enter offset mode, Select **Frequency(Hz)**, press the **ENTER** button to confirm, the present position will blink on the display, use the **UP/DOWN** button to offset the value from 1072 to 1327, press the **ENTER** button to store. Press the **MENU** button to exit.

Red

Enter offset mode, select **Red**, press the **ENTER** button to confirm, the present position will blink on the display, use the **UP/DOWN** button to offset the value from 0 to 255, press the **ENTER** button to store. Press the **MENU** button to exit.

Green

Enter offset mode, select **Green**, press the **ENTER** button to confirm, the present position will blink on the display, use the **UP/DOWN** button to offset the value from 0 to 255, press the **ENTER** button to store. Press the **MENU** button to exit.

Blue

Enter offset mode, select **Blue**, press the **ENTER** button to confirm, the present position will blink on the display, use the **UP/DOWN** button to offset the value from 0 to 255, press the **ENTER** button to store. Press the **MENU** button to exit.

White

Enter offset mode, select **White**, press the **ENTER** button to confirm, the present position will blink on the display, use the **UP/DOWN** button to offset the value from 0 to 255, press the **ENTER** button to store. Press the **MENU** button to exit.

6. Control By Universal DMX Controller

6.1 DMX512 Connection

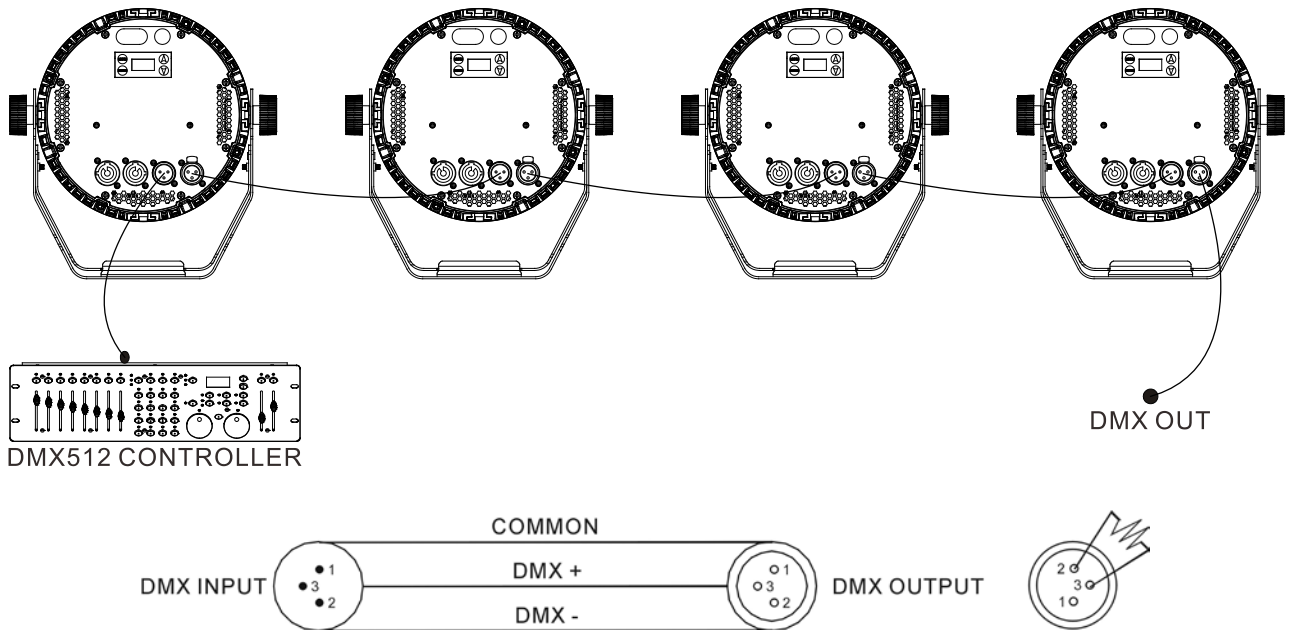

1. At last unit, the DMX cable has to be terminated with a terminator. Solder a 120-ohm 1/4W resistor between pin 2(DMX-) and pin 3(DMX+) into a 3-pin XLR-plug and plug it in the DMX-output of the last unit.
2. Connect the unit together in a “daisy chain” by XLR plug cable from the output of the unit to the input of the next unit. The cable can only be used in series and cannot be connected in parallel. DMX 512 is a very high-speed signal. Inadequate or damaged cables, soldered joints or corroded connectors can easily distort the signal and shut down the system.
3. The DMX output and input connectors are pass-through to maintain the DMX circuit, when one of the units’ power is disconnected.
4. Each lighting unit needs to have a DMX address to receive the data by the controller. The address number is between 1-512.
5. The end of the DMX 512 system should be terminated to reduce signal errors.
6. 3 pin XLR connectors are more popular than 5 pins XLR.
3 pin XLR: Pin 1: GND, Pin 2: Negative signal (-), Pin 3: Positive signal (+)
5 pin XLR: Pin 1: GND, Pin 2: Negative signal (-), Pin 3: Positive signal (+), Pin4, Pin5 not used.

6.2 Address Setting

If you use a universal DMX controller to control the units, you have to set DMX address from 1 to 512 so that the units can receive DMX signal.

Press the MENU button to enter menu mode, select DMX Settings, press the ENTER button to confirm, use the UP/DOWN button to select DMX Address, press the ENTER button to confirm, the present address will blink in the display, use the UP/DOWN button to adjust the address from 001 to 512, press the ENTER button to store. Press the MENU button back to the last menu or let the unit idle 30 seconds to exit menu mode.

Please refer to the following diagram to address your DMX512 channel for the first 4 units.

Channel mode	Unit 1 Address	Unit 2 Address	Unit 3 Address	Unit 4 Address
10 channels	1	11	21	31
8 channels	1	9	17	25
5 channels	1	6	11	16
4 channels	1	5	9	13

6.3 DMX512 Configuration

Please control the fixture by referring to the configurations below

Attentions:

1. The unit will maintain the last condition until reset if you cut-off the DMX signal.
2. For the channel Function, keep the value for about 3 seconds, then the corresponding function will take into effect.

10 Channels (Mode 1):

CHANNEL	VALUE	FUNCTION
1	000-255	RED 0%→100%
2	000-255	GREEN 0%→100%
3	000-255	BLUE 0%→100%
4		WHITE

	000-255	0%→100%
5	000-007 008-015 016-131 132-139 140-181 182-189 190-231 232-239 240-247 248-255	STROBE Close Open Strobe from Slow to Fast Open Slow Open Fast Close Open Fast Open Slow Close Open Random Strobe Open
6	000-255	DIMMER 0%→100%
7	000-255	DIMMER FINE
8	000 001-004 005-009 010-013 014-018 019-022 023-027 028-031 032-036 037-040 041-045 046-049 050-054 055-058 059-063 064-067 068-072 073-076 077-081 082-085 086-090 091-094 095-099 100-103 104-108 109-112 113-117 118-121 122-126	CTO (8000K-2500K) Close 8000K 7900K 7800K 7700K 7600K 7500K 7400K 7300K 7200K 7100K 7000K 6900K 6800K 6700K 6600K 6500K 6400K 6300K 6200K 6100K 6000K 5900K 5800K 5700K 5600K 5500K 5400K 5300K

	127-130 131-135 136-139 140-144 145-148 149-153 154-157 158-162 163-166 167-171 172-175 176-180 181-184 185-189 190-193 194-198 199-202 203-207 208-211 212-216 217-220 221-225 226-229 230-234 235-238 239-243 244-247 248-255	5200K 5100K 5000K 4900K 4800K 4700K 4600K 4500K 4400K 4300K 4200K 4100K 4000K 3900K 3800K 3700K 3600K 3500K 3400K 3300K 3200K 3100K 3000K 2900K 2800K 2700K 2600K 2500K
9	000-009 010-014 015-019 020-024 025-029 030-034 035-039 040-044 045-049 050-054 055-059 060-064 065-069 070-074 075-079 080-084 085-089 090-094	COLOR MACRO Open LEE 790-Moroccan Pink LEE 157-Pink LEE 332-Special Rose Pink LEE 328-Follies Pink LEE 345-Fuchsia Pink LEE 194-Surprise Pink LEE 181-Congo Blue LEE 071-Tokyo Blue LEE 120-Deep Blue LEE 079-Just Blue LEE 132-Medium Blue LEE 200-Double CT Blue LEE 161-State Blue LEE 201-Full CT Blue LEE 202-Half CT Blue LEE 117-Steel Blue LEE 353-Lighter Blue

	095-099 100-104 105-109 110-114 115-119 120-124 125-129 130-134 135-139 140-144 145-149 150-154 155-159 160-164 165-169 170-174 175-179 180-201 202-207 208-229 230-234 235-239 240-244 245-249 250-255	LEE 118-Light Blue LEE 116-Medium Blue Green LEE 124-Dark Green LEE 139-Primary Green LEE 089-Moss Green LEE 122-Fern Green LEE 738-JAS Green LEE 088-Lime Green LEE 100-Spring Yellow LEE 104-Deep Amber LEE 179-Chrome Orange LEE 105-Orange LEE 021-Gold Amber LEE 778-Millennium Gold LEE 135-Deep Gold Amber LEE 164-Flame Red Open Clockwise Rotation, Fast to Slow Stop Counter-clockwise Rotation, Slow to Fast Open Random Color: Fast Random Color: Medium Random Color: Slow Open
10	000-029 030-039 040-049 050-059 060-069 070-099 100-109 110-119 120-199 200-209 210-219 220-229 230-255	FUNCTION No Function Dimmer Curve: Linear Dimmer Curve: Square Law Dimmer Curve: Inv SQ Law Dimmer Curve: S Curve No Function Led Frequency Setting Enable Led Frequency Setting Disable No Function Reset All Dimmer Speed: Fast Dimmer Speed: Smooth No Function

8 Channels (Mode 2):

CHANNEL	VALUE	FUNCTION
1	000-255	RED 0%→100%
2	000-255	GREEN 0%→100%
3	000-255	BLUE 0%→100%
4	000-255	WHITE 0%→100%
5	000-007 008-015 016-131 132-139 140-181 182-189 190-231 232-239 240-247 248-255	STROBE Close Open Strobe from Slow to Fast Open Slow Open Fast Close Open Fast Open Slow Close Open Random Strobe Open
6	000-255	DIMMER 0%→100%
7	000-255	DIMMER FINE
8	000-029 030-039 040-049 050-059 060-069 070-099 100-109 110-119 120-199 200-209 210-219 220-229 230-255	FUNCTION No Function Dimmer Curve: Linear Dimmer Curve: Square Law Dimmer Curve: Inv SQ Law Dimmer Curve: S Curve No Function Led Frequency Setting Enable Led Frequency Setting Disable No Function Reset All Dimmer Speed: Fast Dimmer Speed: Smooth No Function

5 Channels (Mode 3):

CHANNEL	VALUE	FUNCTION
1	000-255	RED 0%→100%
2	000-255	GREEN 0%→100%
3	000-255	BLUE 0%→100%
4	000-255	WHITE 0%→100%
5	000-007 008-015 016-131 132-139 140-181 182-189 190-231 232-239 240-247 248-255	STROBE Close Open Strobe from Slow to Fast Open Slow Open Fast Close Open Fast Open Slow Close Open Random Strobe Open

4 Channels (Mode 4):

CHANNEL	VALUE	FUNCTION
1	000-255	RED 0%→100%
2	000-255	GREEN 0%→100%
3	000-255	BLUE 0%→100%
4	000-255	WHITE 0%→100%

7. Error Information

Error codes are shown continuously in the display when the fixture fails and they will not disappear until the fixture is repaired.

1. LED Tem. Error

Check whether the temperature detecting board is normal.

Check whether the components of the temperature detecting board are damaged.

Check whether the lead on the temperature detecting board is installed in place or disconnected.

2. LED Too Hot Off

When the fixture temperature reaches 80°C, it will automatically turn off to protect the fixture.

3. LED Timeout Use

8. Troubleshooting

Following are a few common problems that may occur during operation. Here are some suggestions for troubleshooting:

A. The unit does not work, no light and the fan does not work

1. Check the connected power.
2. Measure the voltage.
3. Check the power indicator to see whether it can be lit up or not.

B. Not responding to the DMX controller

1. Check whether the DMX connectors and the DMX cables are connected correctly.
2. Check whether the DMX address is correctly set.
3. If the intermittent DMX signal problem occurs, check whether the XLR socket and the signal cable are well connected.
4. Try it with another DMX controller.
5. Check whether the DMX cables run near or alongside to the high-voltage cables, which may damage or interfere with the signal circuit.

C. One of the channels is not working well

1. The stepper motor might be damaged or the cable connected to the PCB might be broken.
2. The motor's drive IC on the PCB might be out of condition.

9. Fixture Cleaning

It is absolutely essential that the fixture is kept clean to ensure the maximum light-output and allow the fixture to function reliably throughout its life. The fixture must be cleaned regularly to avoid dust, dirt and smoke-fluid residues building up on or within the fixture. The cleaning frequency depends on the application environment. Clean the fixture immediately if the dust enters it to avoid damage to the optical lens due to excessive dust.

- A soft lint-free cloth moistened with any good glass cleaning fluid is recommended, under no circumstances should solvents be used.
- Always dry the parts carefully.
- Clean the external optical lens at least every 20 days.

Declaration of Conformity

We declare that our products (lighting equipments) comply with the following specification and bears CE mark in accordance with the provision of the Electromagnetic Compatibility (EMC) Directive 2014/30/EU.

EN 55032: 2015+A11:2020; EN 55035: 2017+A11: 2020;
EN IEC 61000-3-2: 2019; EN 61000-3-3: 2013+A1: 2019.

&

Harmonized Standard

EN 60598-2-17: 2018; EN 60598-1: 2015+A1: 2018.

Safety of household and similar electrical appliances
Part 1: General requirements and tests

Innovation, Quality, Performance